



Automation for a Changing World

Delta Programmable Logic Controller DVP Series



reddot design award
winner 2010

www.deltaww.com

 **DELTA**
Smarter. Greener. Together.

The Perfect Small PLC Revolution!

After launching our first DVP series PLCs for industrial automation applications, Delta has been devoted to delivering more innovative products that satisfy customers' needs and meet the requirements of a wide variety of applications.

Delta PLCs offer a broad range of controllers and modules which all feature high performance, multiple functions and efficient program editing tools. In addition to the user-friendly programming software and faster execution speed, we also provide complete industry-focused solutions, motion control solutions, and industrial fieldbus solutions with Delta's new PLC series.

We integrate our PLCs with industrial automation products to deliver total solutions for various field applications.

As your most reliable partner, Delta is dedicated to creating value for our customers.

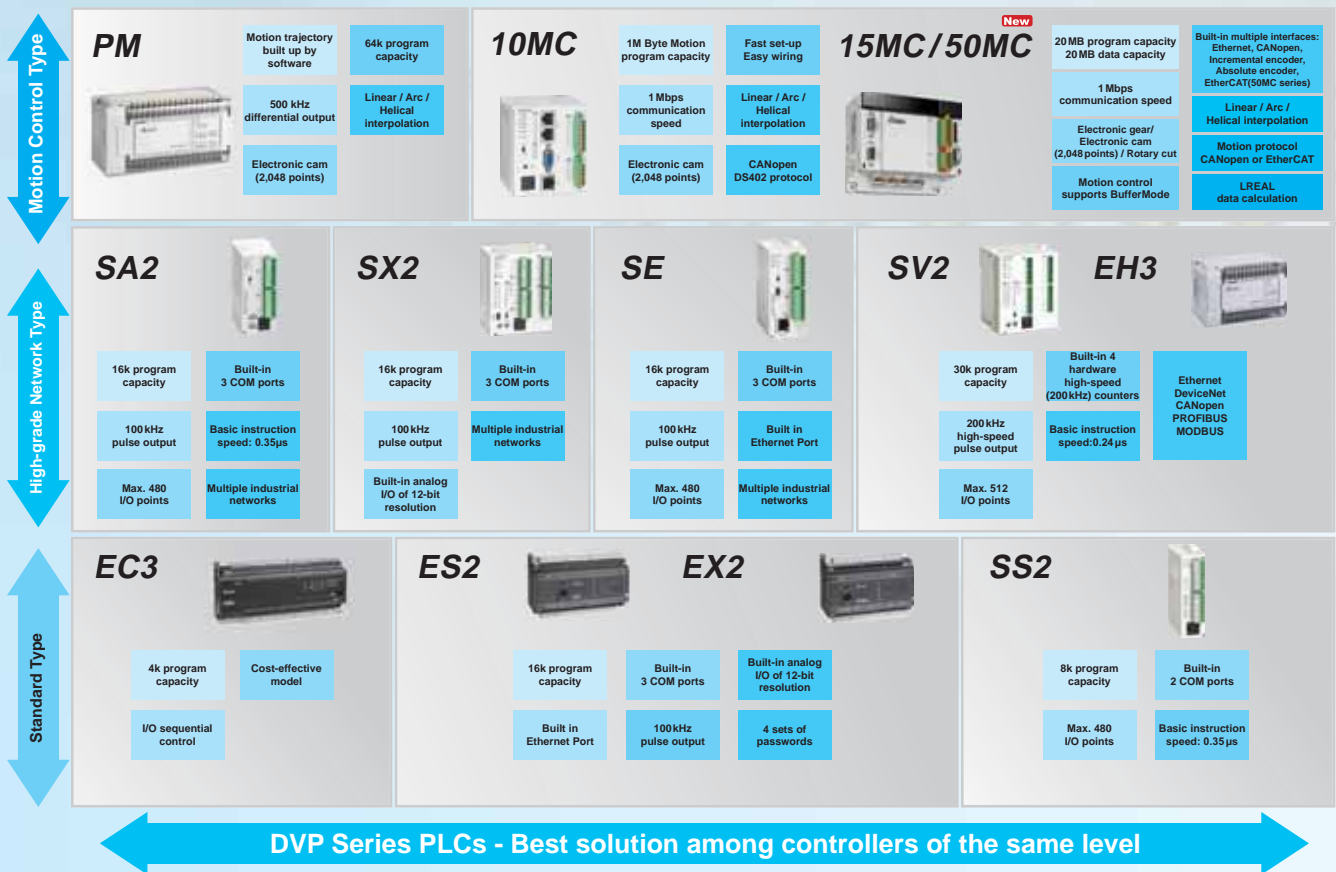

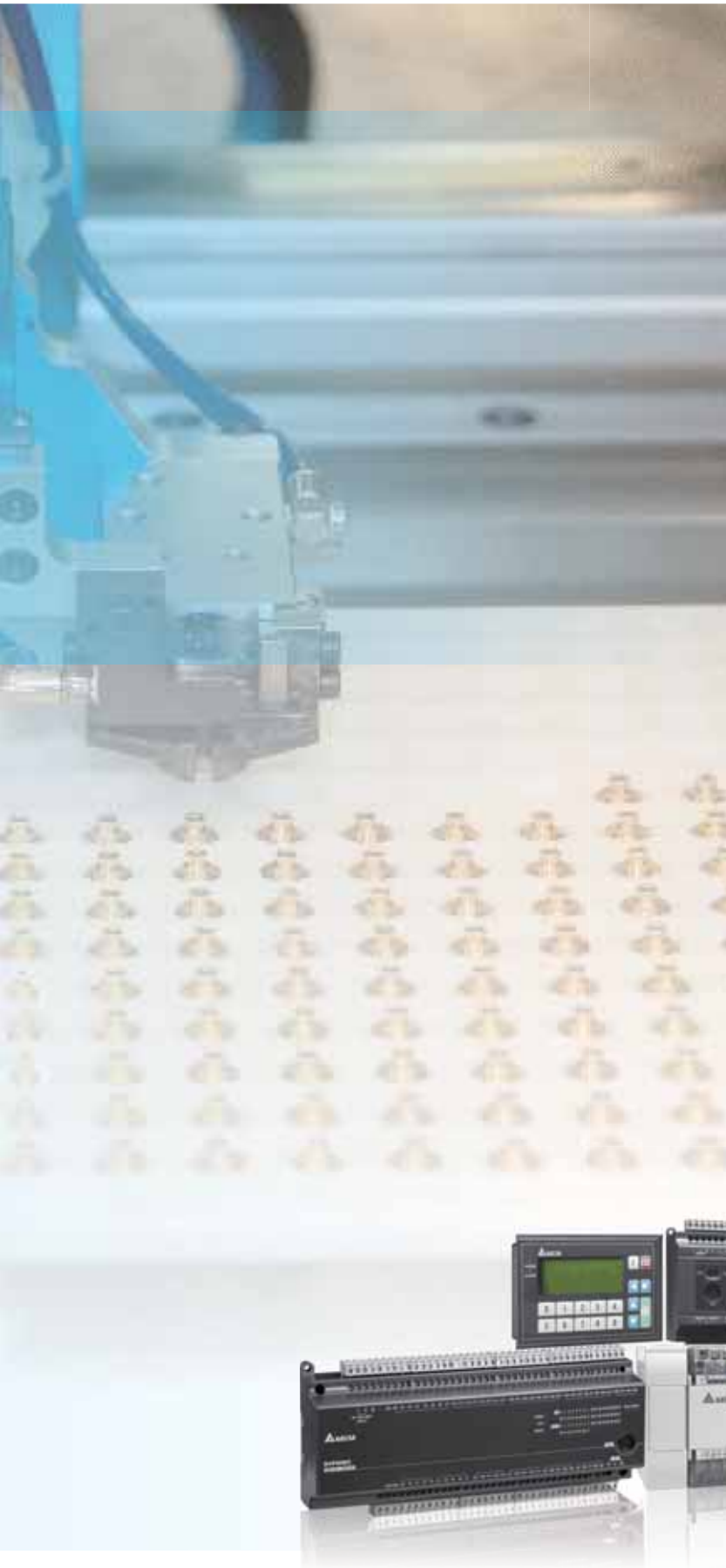

Contents

	Page
Standard PLC DVP-E Series	5
Slim PLC DVP-S Series	8
General Motion Controller DVP-PM Series	11
Multi-axis Motion Controller DVP-MC Series	13
DVP Series Extension Modules	21
Electrical Specifications	26
Dimensions	27
PLC Editing Software ISPSoft	31
Touch / Text Panel HMI with Built-in PLC TP Series	33
DVP Series Model Name Instruction	37
DVP Series Function Overview	38
Ordering Information	39

NEW

Built-in Ethernet for Advanced Applications



Standard PLC DVP-ES2-E

- ▶ Built-in 20 / 32 / 40 / 60 I/O points
- ▶ Built-in Ethernet port that supports MODBUS TCP and EtherNet/IP (slave)

Increased Built-in I/O Points to Enhance Competitiveness for Solutions

PLCs

DVP-28SS2

DVP-28SA2

DVP-26SE

- ▶ 16DI + 12DO (DVP-28SS2, DVP-28SA2)
- ▶ 14DI + 12DO (DVP-26SE)
- ▶ Compatible with DVP-S Series extension modules (right-side)



Complete Interface Design and 24-axis Motion Control



CANopen Motion Controller
DVP-15MC

EtherCAT Motion Controller
DVP-50MC

- ▶ 1GHz CPU
- ▶ Program capacity + data capacity = 20MB + 20MB
- ▶ Up to 24 real axes control

Built-in Interface

16DI 8DO	RS-232	RS485	Ethernet 15MC: x2 50MC: x1	Memory card:SD
CANopen DS301	Motion 15MC: CANopen DS402 50MC: EtherCAT	Incremental encoder interface*2	SSI absolute encoder interface	

Motion Function

Multi-axis Gear / Cam	Linear / Arc / Helical interpolation	Jerk	G-Code	Buffer Mode
--------------------------	--	------	--------	----------------



reddot design award
winner 2010

Basic PLC DVP-EC3

Applicable for sequence control and simple RS-485/MODBUS communication

- ▶ Built-in I/O: 10/14/16/20/24/30/32/40/48/60
- ▶ Program capacity: 4 k steps
- ▶ COM port: Built-in RS-232 & RS-485 ports (10/14-point models do not support RS-485), compatible with MODBUS ASCII/RTU protocol
- ▶ Supports 2 points (Y0, Y1) of independent high-speed (max. 10kHz) pulse output
(Hardware version V8.00 and above support this function)

Built-in High-Speed Counters

1-phase 1 input		1-phase 2 inputs		2-phase 2 inputs	
Counters	Bandwidth	Counters	Bandwidth	Counters	Bandwidth
2/2	20kHz/10kHz	1	20kHz	1	4kHz

Standard PLC / Analog I/O PLC DVP-ES2/EX2

Standard PLCs with integrated communication and highly efficient processing ability for your control systems

- ▶ 32-bit CPU for high-speed processing
- ▶ Standard PLC DVP-ES2 Series: 16/20/24/32/40/60/80 I/O points for a variety of applications
- ▶ Analog I/O PLC DVP-EX2:
 - Built-in 12-bit 4 analog inputs / 2 analog output; and 14-bit analog I/O extension module
 - Built-in PID auto tuning function for a complete analog control solution
- ▶ Built-in 1 RS-232 and 2 RS-485 ports
- ▶ Program capacity: 16k steps
- ▶ Data register: 10k words
- ▶ Max. execution speed of basic instructions: 0.35 μs
- ▶ RTC function and file register (5k words) (hardware version 2.0 and above)
- ▶ Highly efficient processing ability: 1k steps of programs can be completed within 1ms
- ▶ Max. 100 kHz pulse control; specific motion control instructions (mark/masking and instant frequency changing) available for multi-axis applications
- ▶ Up to 4 levels of password protection secures your source programs and intellectual property

Built-in High-Speed Counters

1-phase 1 input		1-phase 2 inputs		2-phase 2 inputs	
Counters	Bandwidth	Counters	Bandwidth	Counters	Bandwidth
2/6	100kHz/10kHz	2	100kHz	1/3	15kHz/5kHz



Standard PLC with built-in CANopen interface

DVP32ES200RC/TC

Boosts productivity with high execution speed and built-in CANopen interface, and specializes in noise-immunity and easy wiring

- ▶ Built-in 1Mbps CANopen interface; COM3 supports standard CANopen DS301 protocol
- ▶ Versatile communication types: PDO, SDO, synchronous (SYNC), Emergency, NMT and many more
- ▶ 1Mbps high-speed transmission for large data:
 - Max. PDO transmission: up to 390 bytes
 - Max. PDO receiving: up to 390 bytes
- ▶ Ability to connect with 16 slaves via CANopen
- ▶ Built-in 1 RS-232 and 1 RS-485 ports

Fast processing speed

High-speed industrial network: CANopen

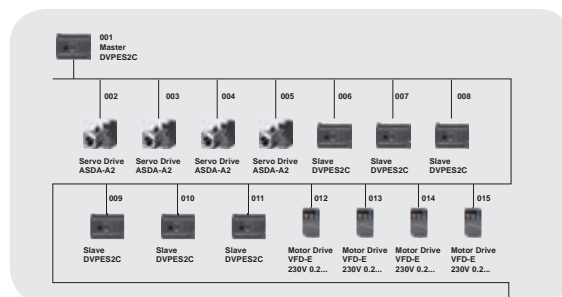

Standard PLC with built-in Ethernet interface

DVP-ES2-E

Higher communication speed and easier external connection with built-in Ethernet

- ▶ Built-in I/O: 20/32/40/60
- ▶ Communication speed: 100M
- ▶ Supports MODBUS and EtherNet/IP (slave)
- ▶ Built-in 1 RS-232 and 2 RS-485 ports

Built-in Ethernet			
MODBUS		EtherNet/IP	
Number of Connections	Server: 16 Client: 8	Number of Connections	TCP: 4 CIP: 8
Max. Data Exchange (each connection)	100 words	Max. Data Exchange (each connection)	250 words
		RPI	5~1,000 ms
		PPS	1,000 PPI

Temperature / Analog I/O PLC

DVP30EX200R/T

Integrated controller for temperature control and analog input

- ▶ Built-in 16-bit 3 analog inputs / 12-bit 1 analog output
- ▶ Built-in PID auto tuning function to offer a complete analog control solution
- ▶ 3 analog inputs for Pt / Ni temperature input, precision of 0.1 degree can be readily achieved

Built-in Analog I/O in DVP-EX2 Model			
Analog Input		Analog Output	
Channels	3	Channels	1
Resolution	16-bit	Resolution	12-bit
Spec.	-20~20 mA or -10~10V	Spec.	0~20 mA or -10~10V
Built-in Temperature Control Function			
Sensor	Pt100/Pt1000	Ni100/Ni1000	
Temperature Range	-200°C~800°C	-100°C~180°C	
Value Range	-2,000~8,000	-1,000~1,800	



High Performance PLC

DVP-EH3

High-end model of Delta's DVP-E Series PLC with large program capacity and data registers for demanding and complex applications

Program capacity

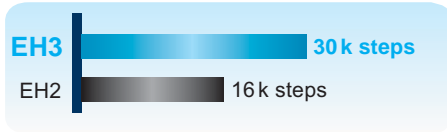

Data register

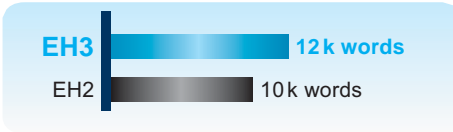

Execution speed

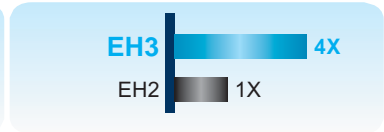

Excellent Motion Control

- ▶ High-speed pulse output: 4 axes of 200 kHz pulse output (DVP32/40/48/64/80EH00T3)
- ▶ Supports max. 4 hardware 200 kHz high-speed counters
- ▶ Various motion control instructions to achieve high-speed and high-precision positioning control for labeling machines, packaging machines, printing machines and more applications
- ▶ Linear / arc interpolation motion control function
- ▶ Provides up to 16 external interrupt pointers

Complete Program Protection

- ▶ Auto backup function prevents program and data loss even when the battery runs out
- ▶ Secondary backup function saves an extra copy of programs and data to enhance program safety
- ▶ Up to 4 levels of password protection protects your source programs and intellectual property

Outstanding Operation Performance

- ▶ 32-bit CPU + ASIC dual processors support floating point operations
- ▶ Max. execution speed of basic instructions: 0.24μs

Flexible Function Extension Modules & Cards

- ▶ Multiple selections of extension modules and function cards: analog I/O, temperature measurement, additional single-axis motion control, high-speed counting
- ▶ 3rd serial communication port and Ethernet communication card are available

PLC Link

- ▶ PLC Link allows users to link up a max. of 32 units to the network without extra communication extension modules

Built-in 4 Hardware High-Speed Counters							
Standard		Hardware high-speed counter					
1-phase 1 input		1-phase 1 input		1-phase 2 inputs		2-phase 2 inputs	
Counters	Bandwidth	Counters	Bandwidth	Counters	Bandwidth	Counters	Bandwidth
8	10kHz	4	200kHz	4	200kHz	4	200kHz

The specifications of high-speed input and output on this page are applicable only for DVP40EH00R3 / DVP40EH00T3.

Refer to the I/O specifications table on page 20 for more information on other models.



High Performance Slim PLC

DVP-SV2

High-end model of the DVP-S Series with larger program capacities and data registers for more demanding and complex applications

Program capacity

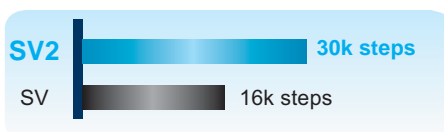

Data register

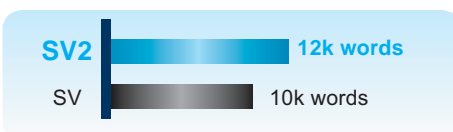

Execution speed

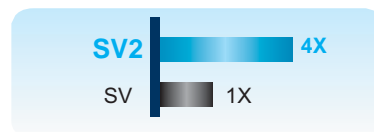

Excellent Motion Control

- ▶ High-speed pulse output: 4 axes of 200 kHz pulse output
- ▶ Supports 4 hardware 200 kHz high speed counters
- ▶ Various motion control instructions to achieve high-speed and high-precision positioning control for labeling machines, packaging machines, printing machines and more applications
- ▶ Linear / arc interpolation motion control function
- ▶ Provides up to 16 external interrupt pointers

Complete Program Protection

- ▶ Auto backup function prevents program and data loss even when the battery runs out
- ▶ Secondary backup function saves an extra copy of programs and data to enhance program safety
- ▶ Up to 4 levels of password protection protects your source programs and intellectual property

Supports DVP-S Series modules (left-side and right-side); additional new Ethernet communication command (ETHRW)

Outstanding Operation Performance

- ▶ 32-bit CPU + ASIC dual processors support floating point operations
- ▶ Max. execution speed of basic instructions: 0.24μs

The DVP-24SV2 model has a built-in 2AI (12-bit) with Y10/Y12 of 10 kHz output.

Built-in 4 Hardware High-Speed Counters							
Standard		Hardware high-speed counter					
1-phase 1 input		1-phase 1 input		1-phase 2 inputs		2-phase 2 inputs	
Counters	Bandwidth	Counters	Bandwidth	Counters	Bandwidth	Counters	Bandwidth
8	10 kHz	4	200 kHz	4	200 kHz4	4	200 kHz

The X11 / X15 have been upgraded to 200kHz since 2016 October



Standard Slim PLC

DVP-SS2

Economic and compact model

- ▶ 32-bit CPU for high-speed processing
- ▶ Max. I/O: 480 points
- ▶ Program capacity: 8k steps
- ▶ Data register: 5k words
- ▶ Max. execution speed of basic instructions: 0.35 μs
- ▶ Built-in RS-232 and RS-485 ports (Master/Slave)
- ▶ Supports standard MODBUS ASCII/RTU protocol and PLC Link function

Motion Control Functions

- ▶ 4 points of 10 kHz pulse output
- ▶ 8 points of high-speed counters: 20kHz/4 points, 10kHz/4 points

Advanced Slim PLC

DVP-SA2

Advanced model supporting 2-axis interpolation

- ▶ 32-bit CPU for high-speed processing
- ▶ Program capacity: 16k steps
- ▶ Data register: 10k words
- ▶ Max. execution speed of basic instructions: 0.35 μs
- ▶ Built-in 1 RS-232 and 2 RS-485 ports (Master/Slave)
※ Note: RS-485 will be reduced to 1 port in DVP28SA2
- ▶ Supports standard MODBUS ASCII/RTU protocol and PLC Link function
- ▶ No battery required; RTC function operates for 15 days after power off
- ▶ Supports DVP-S Series modules (left-side and right-side)
※ Note: DVP28SA2 only supports right-side modules

Motion Control Functions

- ▶ 4 points of high-speed pulse output: 100kHz/2 points, 10kHz/2 points
- ▶ 8 points of high-speed pulse input: 100kHz/2 points, 10kHz/6 points, 1 set of A/B phase 50kHz
- ▶ Supports 2-axis linear and arc interpolation

Built-in High-Speed Counters					
1-phase 1 input		1-phase 2 inputs		2-phase 2 inputs	
Counters	Bandwidth	Counters	Bandwidth	Counters	Bandwidth
4/4	20kHz/10kHz	2	20kHz	2/2	10kHz/5kHz

Built-in High-Speed Counters					
1-phase 1 input		1-phase 2 inputs		2-phase 2 inputs	
Counters	Bandwidth	Counters	Bandwidth	Counters	Bandwidth
2/6	100kHz/10kHz	2	100kHz	1/3	50kHz/5kHz



Analog I/O Slim PLC

DVP-SX2

Analog model with highly efficient PID control function

- ▶ 32-bit CPU for high-speed processing
- ▶ Program capacity: 16k steps
- ▶ Data register: 10k words
- ▶ Max. execution speed of basic instructions: 0.35 μs
- ▶ Built-in 4 analog inputs / 2 analog outputs
- ▶ Built-in mini USB, RS-232 and RS-485 ports (Master/Slave)
- ▶ Supports standard MODBUS ASCII/RTU protocol and PLC Link function
- ▶ PID Auto Tuning function for highly efficient PID control
- ▶ No battery required; RTC function operates for at least one week after power off (hardware version 2.0 and above)
- ▶ Supports DVP-S Series modules (left-side and right-side)

Motion Control Functions

- ▶ 4 points of high-speed pulse output: 100 kHz/2 points, 10 kHz/2 points
- ▶ 8 points of high-speed pulse input: 100 kHz/2 points, 10 kHz/6 points
- ▶ Supports 2-axis linear and arc interpolation

Built-in Analog I/O			
Analog Input		Analog Output	
Channels	4	Channels	2
Resolution	12-bit	Resolution	12-bit
Spec.	-20~20mA or -10~10V or 4~20mA	Spec.	0~20mA or -10V~10V or 4~20mA

Network Type Advanced Slim PLC

DVP-SE

Complete network communication functions for advanced industrial applications

- ▶ 32-bit CPU for high-speed processing
- ▶ Program capacity: 16k steps
- ▶ Data register: 12k words
- ▶ Max. execution speed of basic instructions: 0.64 μs
- ▶ Built-in Ethernet
DVP12SE : MODBUS & Ethernet/IP (Explicit message)
DVP26SE : MODBUS & Ethernet/IP (Adapter mode, explicit message)
- ▶ Built-in mini USB port, RS-485 port*2 and Ethernet port that supports MODBUS TCP and EtherNet/IP Slave (adapter)
※ Note: RS-485 will be reduced to 1 port in DVP26SE
- ▶ IP Filter functions as firewall for first line protection against malware and network threats
- ▶ Supports DVP-S Series modules (left-side and right-side)
※ Note: DVP26SE only supports right-side modules
- ▶ No battery required; RTC function operates for 15 days after power off

Motion Control Functions

- ▶ 4 points of high-speed pulse output: 100 kHz / 2 points, 10 kHz / 2 points
- ▶ 8 points of high-speed pulse input: 100 kHz / 2 points, 10 kHz / 6 points, 1 set of A / B phase 50 kHz
- ▶ Supports 2-axis linear and arc interpolation

Built-in High-Speed Counters					
1-phase 1 input		1-phase 2 inputs		2-phase 2 inputs	
Counters	Bandwidth	Counters	Bandwidth	Counters	Bandwidth
2/6	100kHz/ 10kHz	2	100kHz	1/3	50kHz/ 5kHz

General Motion Controller

DVP-PM



Standard Motion Controller DVP10PM00M

Standard motion controller for general applications

- ▶ Built-in 24 I/O points. Max. 256 I/O points
- ▶ Program capacity: 64 k steps
- ▶ Data register: 10 k words
- ▶ Execution speed LD: 0.13 μ s, MOV: 2.1 μ s
- ▶ Built-in RS-232 and RS-485 ports
- ▶ 2 / 3 / 4 / 5 / 6 axes linear interpolation motion control
- ▶ Highly accurate PWM 200 kHz output, resolution 0.3%
- ▶ 8 groups of high-speed captures (mark correction, frequency measurement), comparative output, Mark / Mask function (for bag making)
- ▶ Supports standard MODBUS ASCII / RTU protocol

Motion Control Functions

- ▶ High-speed pulse output: built-in 6 sets of A/B phase pulse outputs
- ▶ 2 sets of 200 kHz output, 4 sets of 1 MHz output
- ▶ 6 sets of high-speed counters and hardware digital filter for counting
- ▶ Supports MPG inputs
- ▶ Single-axis motion control function (supports MPG, single-speed and two-speed positioning)
- ▶ Electronic gear function

Advanced Motion Controller DVP20PM00D/M/DT

Excellent as motion controllers or extension modules and supports advanced motion control functions

- ▶ Built-in 16 I/O points. Max. 512 I/O points
- ▶ Program capacity: 64 k steps
- ▶ Data register: 10 k words
- ▶ Compatible with G-code / M-Code
- ▶ 3-axis linear/arc/helical interpolation
- ▶ Supports electronic cam (2,048 points) function for flying shear and rotary cut applications
- ▶ All models can be applied as motion controllers or extension modules
- ▶ Built-in RS-232 and RS-485 ports, and supports standard MODBUS ASCII/RTU protocol

Motion Control Functions

- ▶ Built-in A/B phase differential signal outputs: 2 sets (DVP20PM00D)/3 sets (DVP20PM00M)
Max. differential output frequency: 500 kHz
- ▶ Supports MPG inputs
- ▶ Single-axis motion control function (supports MPG, single-speed and two-speed positioning)
- ▶ Electronic gear function

Function Cards for DVP-PM

Model Name	Specifications	Features
DVP-FPMC	Ethernet/CANopen communication card	1. Complies with CANopen CiA301 V4.0.2 protocol. 2. Provides high-speed program upload/download via Ethernet.

* DVP-PM also supports DVP-EH series function cards: DVP-F2AD, DVP-F2DA, DVP-F232S and DVP-F485S

General Motion Controller DVP-PM Series: Pulse-train communication

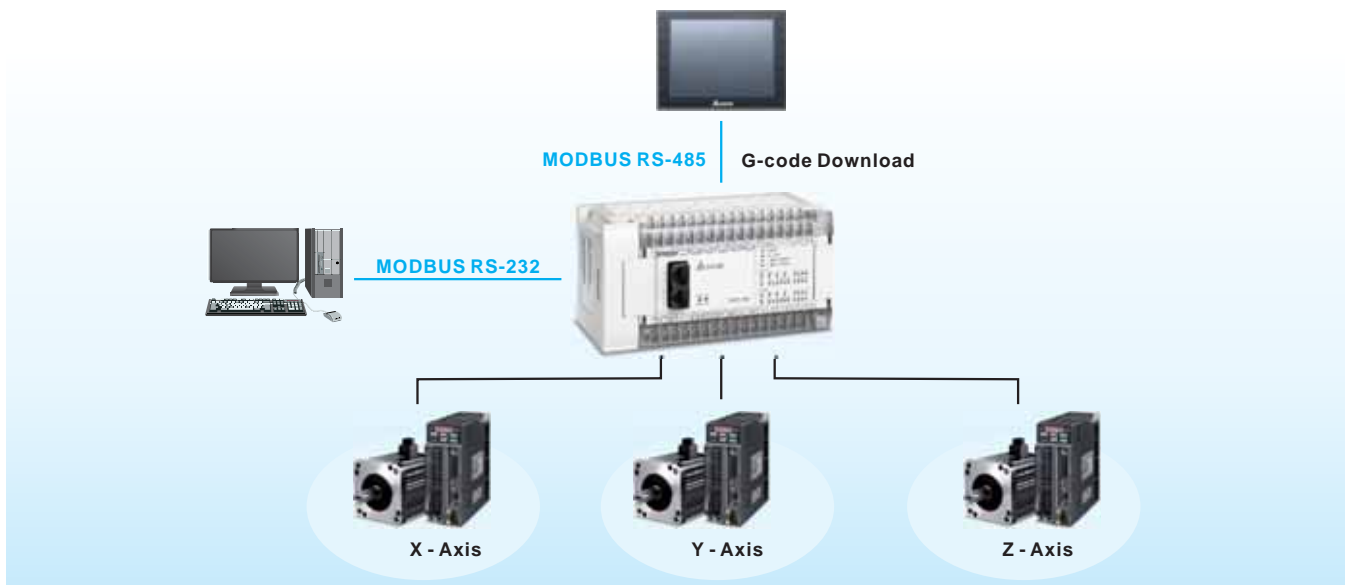

Programming Software for DVP-PM Series: PMSoft

The programming software for G-Code editing, motion path simulation, positioning route planning and electronic cam setup

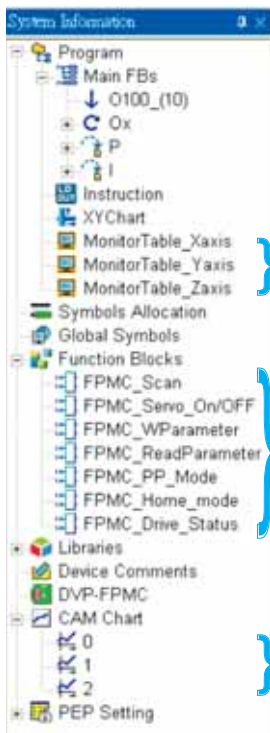

Variable Declaration

Separate from the program. The corresponding physical I/O point of the variable is defined only after the program is compiled. Users do not need to modify the program.

Class	Identifier	Address	Type	Initial	Comment
VAR	Axis_Scan		FFMC_Scan		FFMC對ASD-A2的掃描
VAR	Axis_Enable		FFMC_Servo_On/OFF		FFMC對ASD-A2的使能
VAR	Axis_WIP		FFMC_WParameter		FFMC對ASD-A2的寫入
VAR	Axis_OP		FFMC_ReadParameter		FFMC對ASD-A2的讀出

Function Block

- A completed project can be divided into many function blocks.
- Every function block can be used repeatedly, and the import / export function makes the programming more convenient.



Comprehensive Monitoring

The "program monitoring" and "device monitoring" allow users to keep track of program operation.

Motion Network Function Block

PLCopen Function Block allows users to easily use motion control functions



Electronic Cam

Electronic cam editing

Multi-axis Motion Controller

DVP-MC

16-axis Motion Controller

DVP10MC11T

Perfect controller to offer highly stable multi-axis motion control solutions through CANopen communication

- ▶ Built-in 12 I/O points (8 sets of high-speed inputs, 4 sets of high-speed outputs)
- ▶ Up to 16 axes synchronous control through CANopen communication
- ▶ Synchronization time: 4 axes in 2ms / 8 axes in 4ms
- ▶ Built-in motion control instructions of electronic cam, flying shear, rotary cut for easy operation
- ▶ High precision control with interpolation function

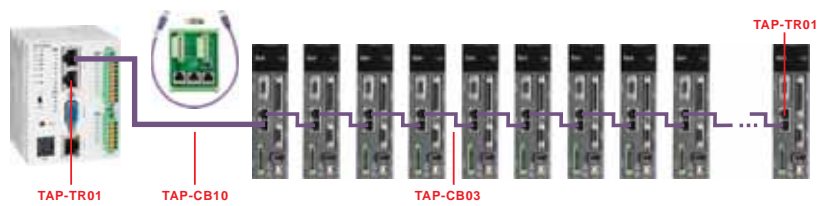

System Control Architecture

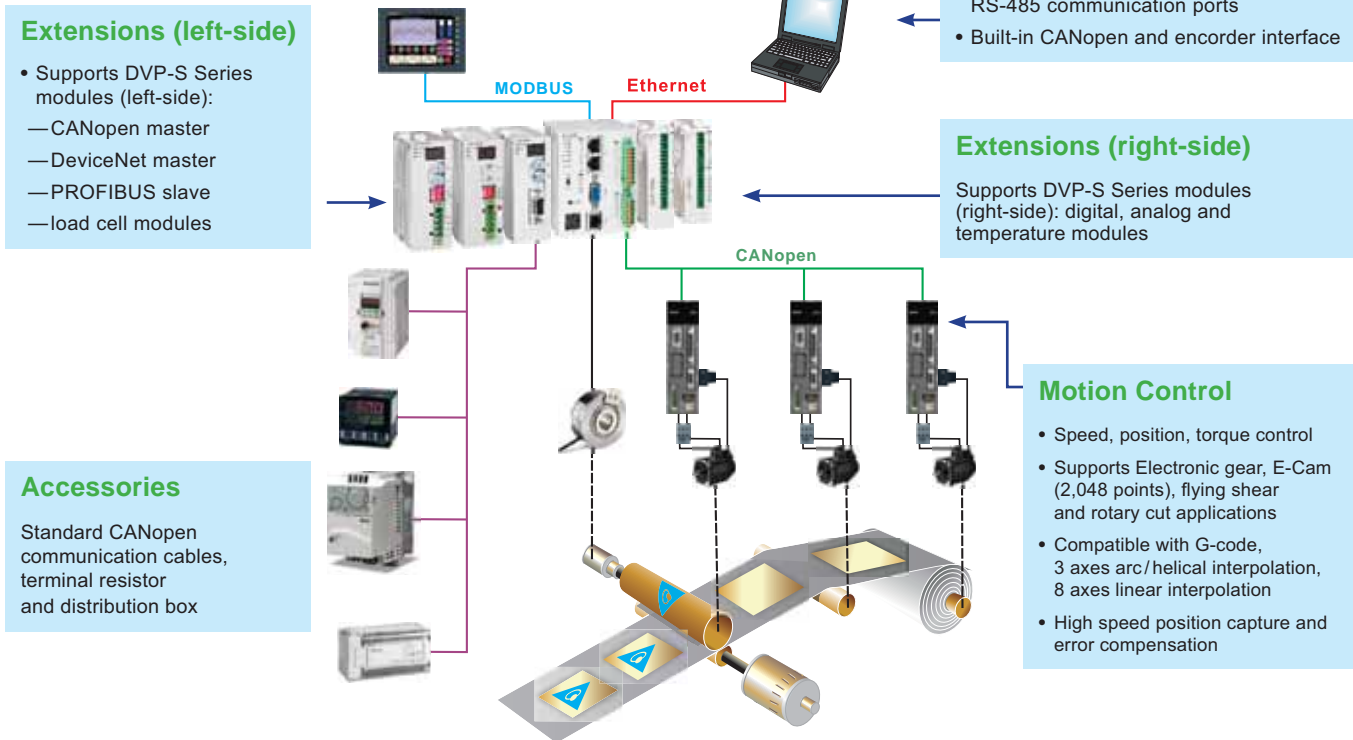

CANopen Accessories		
Model Name	Specifications	Features
	CANopen sub-line	RJ45 connector for both ends
	CANopen main-line/sub-line	AWG18/AWG24 CANopen cables for long distance communication via CANopen
	Distribution box	Built-in terminal resistor 120Ω
	Terminal resistor	Terminal resistor 120Ω

6 and 24-axis Motion Controller

DVP15MC / DVP50MC series New

The DVP15MC/DVP50MC Series is a multi-axis motion controller designed for the CANopen / EtherCAT network architecture. It supports CANopen/EtherCAT with built-in motion control instructions (BufferMode and Jerk) for flexible configuration and fast project development. DVP15MC/DVP50MC controls up to 24 real axes via Motion port. It also supports single axis motion control instructions such as speed, position, torque, homing, position setup and multi-axis motion control instructions such as electronic gear, electronic cam (E-Cam), rotatory cut and G-code.

DVP15MC/DVP50MC features multiple built-in communication interfaces, and can be easily connected to other equipment without additional communication modules. It also provides high-speed and reliable motion control via CANopen/EtherCAT for printing, packaging, wire cutting, robots and other automation control industries.

Motion Control

- Up to 24 real axes control (virtual axis no.: 1~32, can't be repetitive with real axis no.)
- Built-in motion control instructions and easy to use
- Supports encoder axis and virtual axis
- Single axis motion control instructions: speed, torque, homing, and position setup
- Application instructions: electronic gear, E-Cam, and rotary cut
- G-code: 8 axes linear/arc/helical interpolation
- Coordinates motion control instructions

Performance

- 1 GHZ high-speed floating point operation
- High-precision computing: supports LREAL (Double-precision floating-point format)
- Synchronization time:
 - DVP15MC: 4 axes in 2ms, 8 axes in 4ms
 - DVP50MC: 32 axes in 1ms
- Program capacity: 20 MB
- Data capacity: 20 MB

External Interfaces

- 1 CANopen port as host or slave station
- 1 Motion port (DVP15MC: CANopen, DVP50MC: EtherCAT)
- 16 high-speed inputs/8 high-speed outputs
- 2 incremental encoder interfaces
- 1 SSI absolute encoder interface
- Ethernet port: DVP15MC x2, DVP50MC x1
- 1 SD card slot
- 1 RS-232 port and 1 RS-485 port
- Extension:
 - Left-side: supports up to 8 DVP-S Series modules (master/slave/load cell modules)
 - Right-side: compatible with DVP-S Series modules (240 I/O, 8 special modules)



Motion Network and Wiring

- DVP15MC
 - Motion network: CANopen
 - Communication speed: Max. 1Mbps
 - Distance: Max. 100m (at 500 kbps)
- DVP50MC
 - Motion network: EtherCAT
 - Communication speed: Max. 100Mbps
 - Distance: Max. 50m (Node-to-node)
- Simple wiring, plug-and-play

DVP15MC/DVP50MC Interface

Multiple built-in communication interfaces allow easy connection to other equipment without additional communication modules.

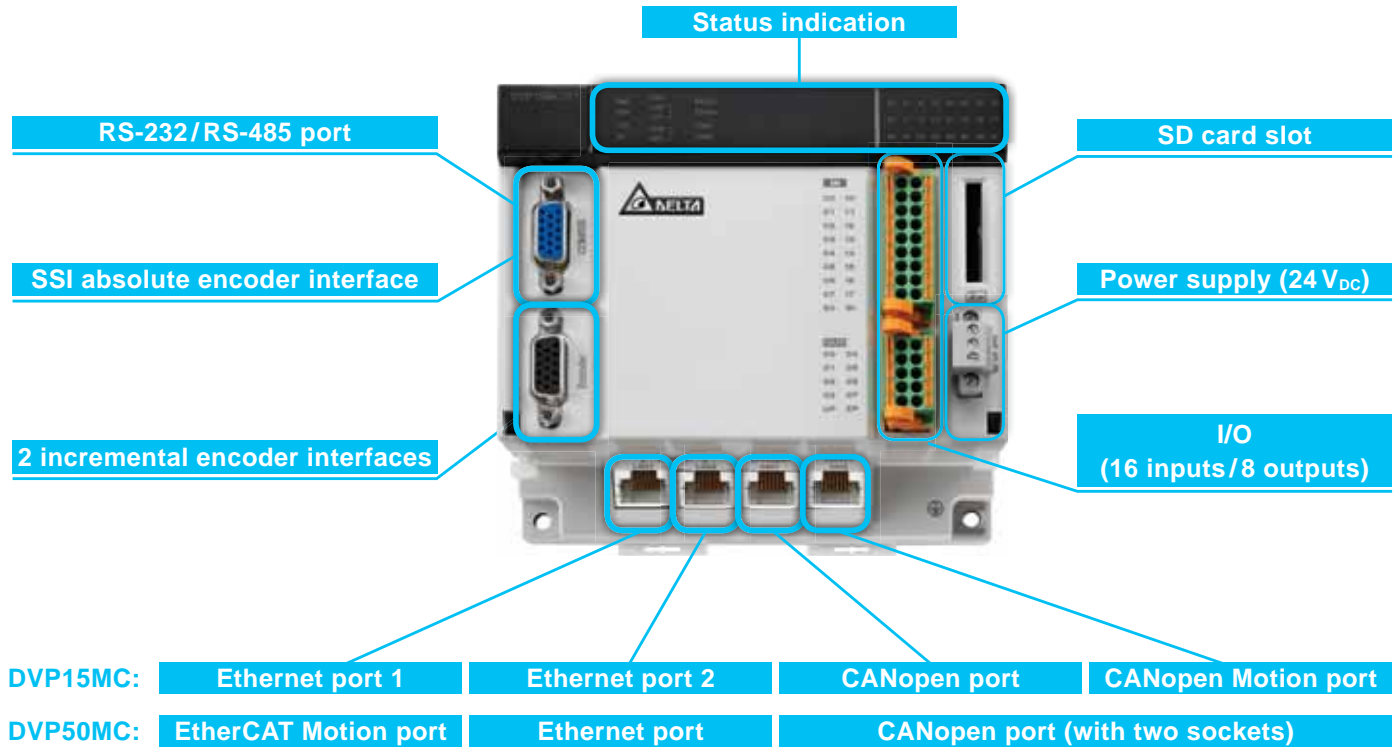

Simple Wiring, Plug-and-Play Motion Control Network

The DVP15MC/DVP50MC features stable CANopen / EtherCAT communication, simple wiring, plug-and-play functions, and communicates with servo drives (axes) via CANopen/EtherCAT network. Delta provides communication cable, terminal resistor and distribution box.

*Please refer to "Accessories" for detail information.

DVP15MC:

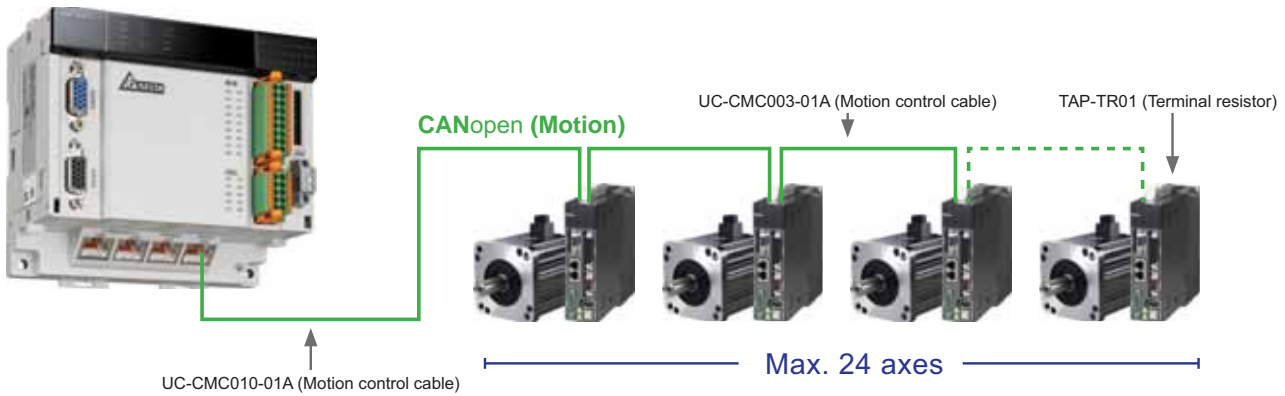

DVP50MC:

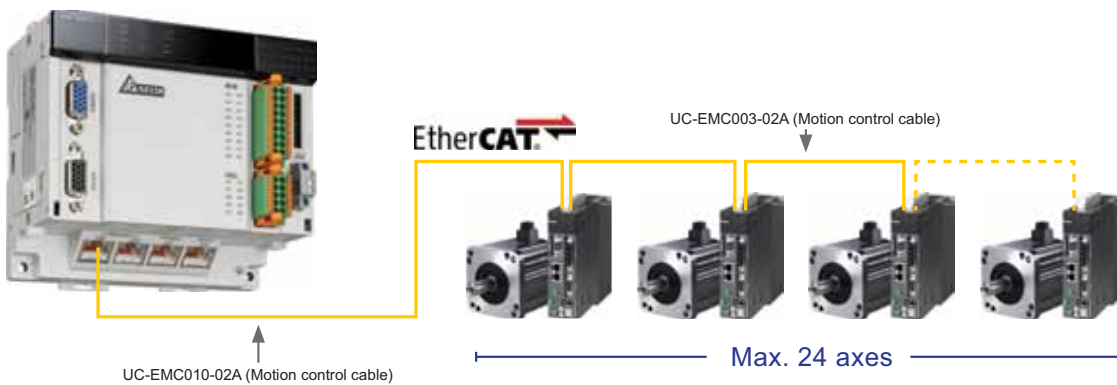

Compatible with Servo Drives via Motion Port

- Delta's AC Motor Drives ASDA-A2-XXXX*-M models support CANopen communication, and they are the only models that can be connected to a DVP15MC CANopen (Motion) port and DVP10MC11T for motion control networks.
- Delta's AC Motor Drives ASDA-A2-XXXX*-E models support EtherCAT communication, and they are the only models that can be connected to a DVP50MC EtherCAT (Motion) port for motion control networks.

The standard CANopen port of DVP15MC/DVP50MC can be connected to all equipment that supports CANopen networks. The ASDA-A2 Series models provide high positioning accuracy and low-speed operation stability when matched with ECMA Series servo motors with high-precision encoder (20-bit resolution and 1,280,000 pulse/rev).

* XXXX represents output power and input voltage.



System Structure

DVP15MC/DVP50MC provides multiple industrial networks. As in the structure shown below, DVP15MC/DVP50MC can be connected to a variety of industrial automation equipment via Ethernet (upper layer), EtherCAT, CANopen, DeviceNet, PROFIBUS DP (middle layer) and RS-485 (lower layer, support Modbus).

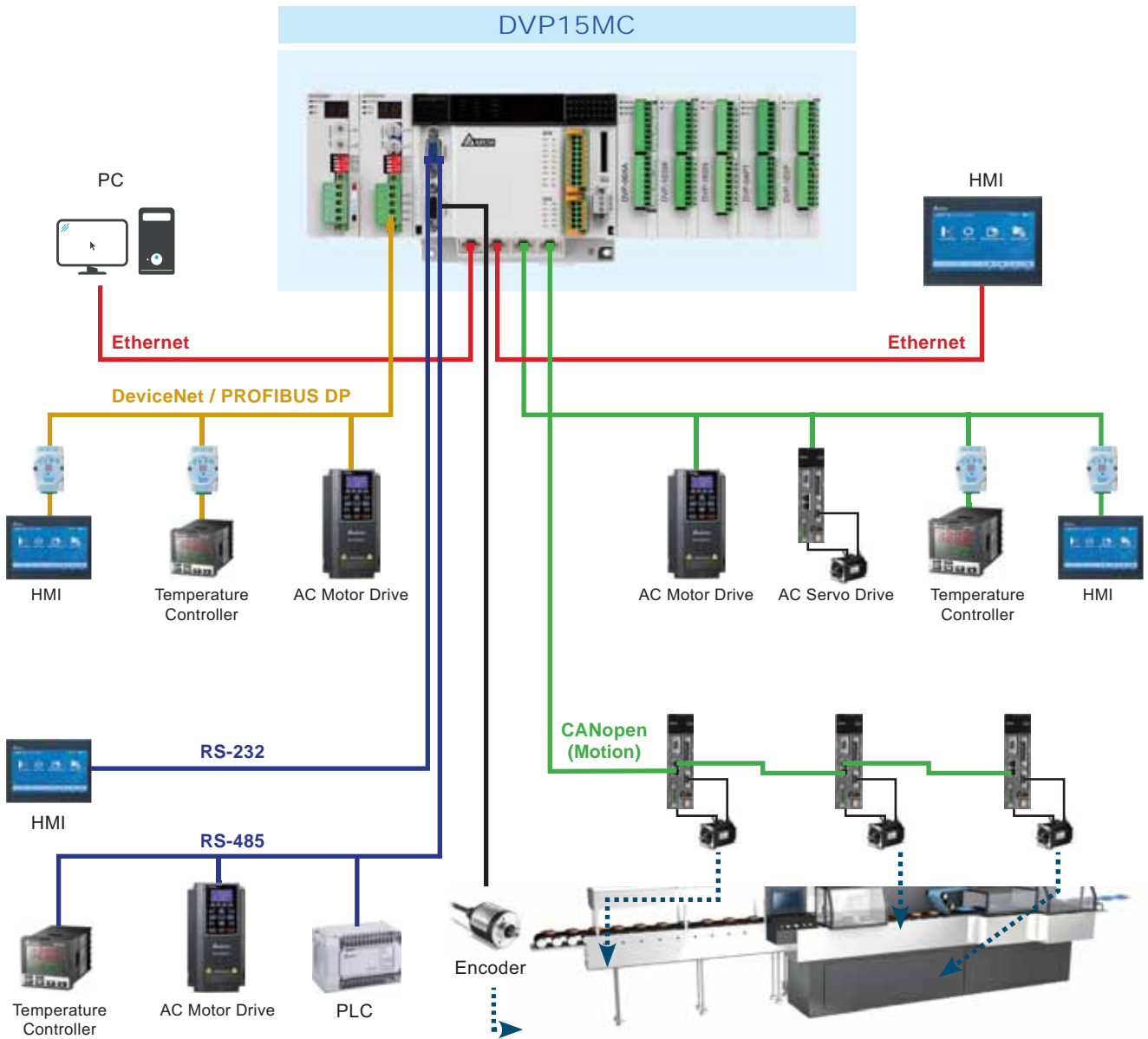

DVP50MC

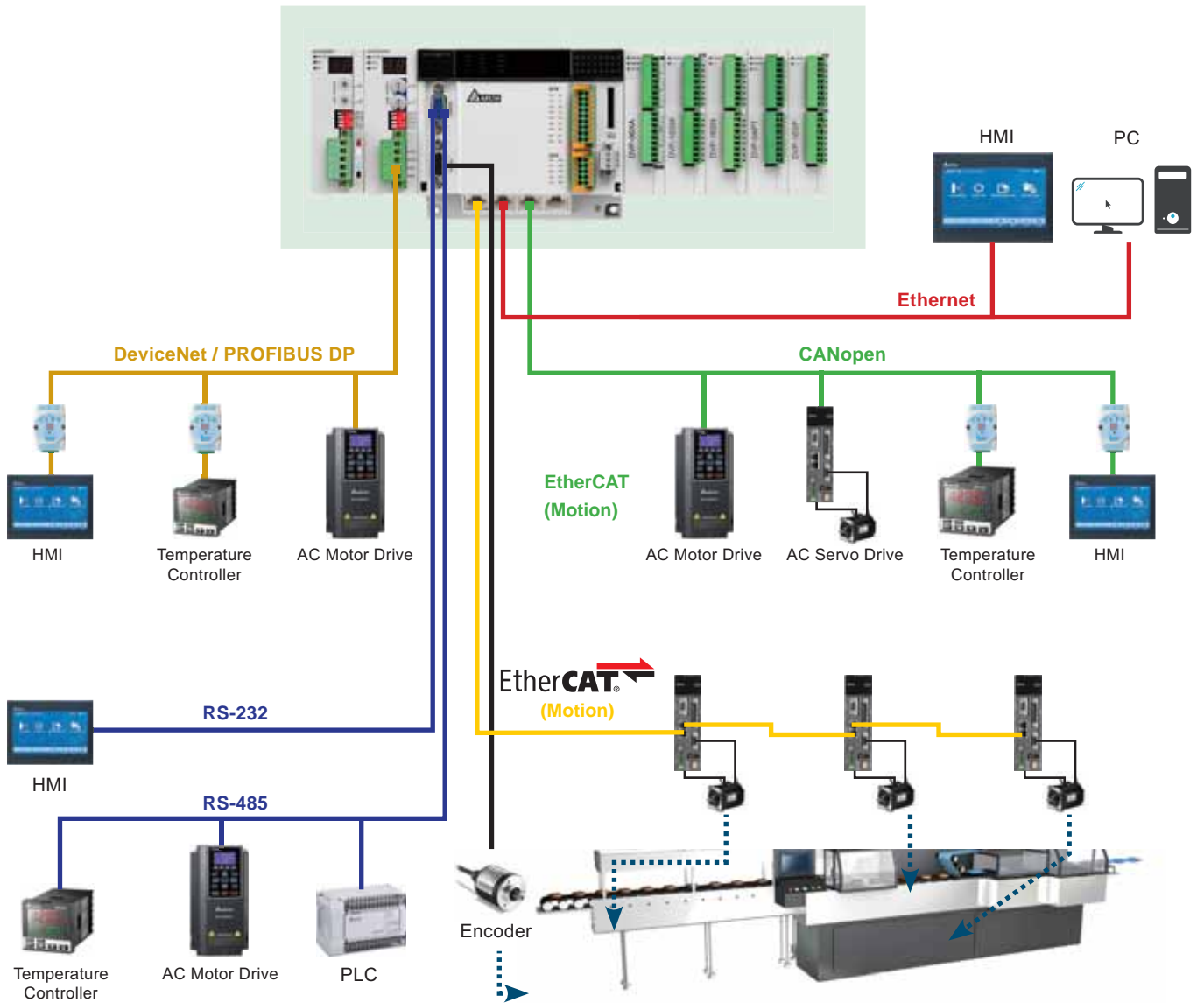

Motion Control

Supports BufferMode and Jerk motion instructions:

		Rel			
Axis1	Axis	MC_MoveRelative	Done	Rel_Done	
Rel_Ex	Execute		Busy	Rel_Bsy	
	Continuous Update		Active	Rel_Act	
LREAL #900.0	Distance		CommandAborted	Rel_Abt	
LREAL #500.0	Velocity		Error	Rel_Err	
LREAL #100.0	Acceleration		ErrorID	Rel_ErrID	
LREAL #100.0	Deceleration				
LREAL #100.0	Jerk				
Rel_BM	BufferMode				

Supports Jerk motion instruction: modify the Jerk value to make the velocity curve smoother

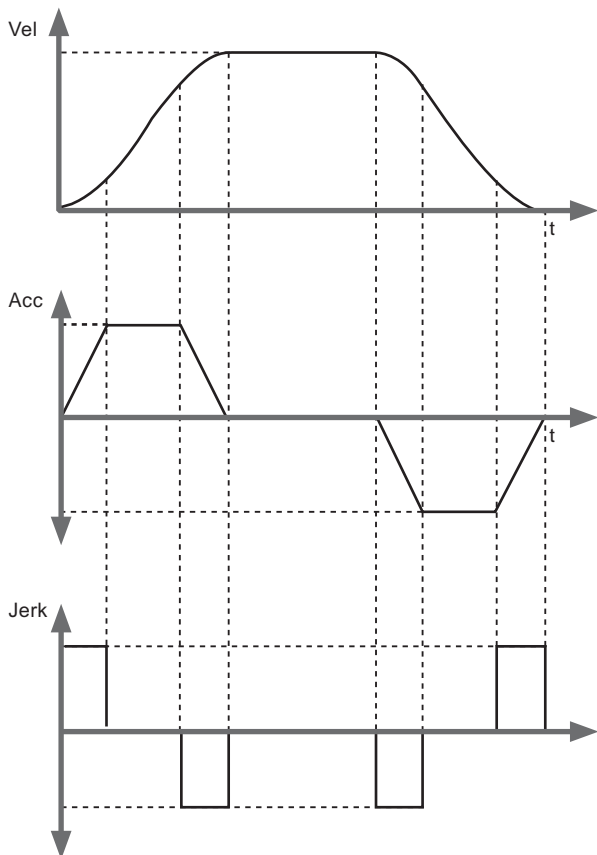

Supports BufferMode motion instruction: enables smooth transition between 2 instructions

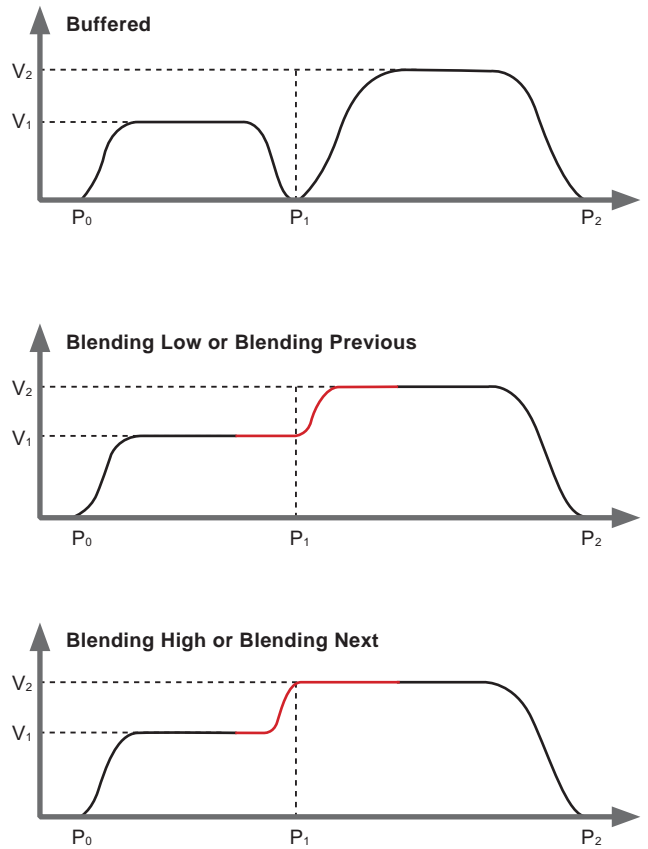

CANopen Configuration Software: CANopen Builder

- Features network arrangement, motion control programming, G-code editor / graph preview and E-Cam curve planning
- Supports international standard function blocks for motion control, enhancing program editing efficiency

The screenshot shows the CANopen Builder software interface. It includes a project tree on the left, a central workspace for network and ladder logic diagrams, a G-code editor at the bottom left, and a graph preview area at the bottom right. Callout boxes point to specific features:

- Network Arrangement:** Network scanning for listing all the equipment.
- Motion Control:** Supports international standard function blocks for motion control.
- G-code Editor and Preview:** G-code editing and preview, direct DXF files import available.
- Program Editing:** CFC, LD, ST, function blocks connection and syntax check.
- E-Cam Curve Planning:** Allows users to plan E-Cam curves according to their needs for more complex control.

Professional Motion Control Applications

Designed as the most outstanding and economical motion controller, the DVP-PM Series provides flying shear, rotary cut, electronic cam and many advanced functions to achieve highly precise motion control

Robot Arm

Electronic Cam (E-Cam) function enables the robot arm to perform multi-axis control. After the required positions are memorized in the PLC, users can enable the electronic cam function to create the E-Cam profile and conduct trajectory tracking and multi-axes motion control required in robot arm applications.



High-Speed Cutting Machine

Average PLC cutting motion is limited by operation speed, poor synchronization, large amounts of calculations and long CPU processing time, resulting in a disproportionate cutting result and affecting the quality of end products. The basic demands, however, can be fulfilled under low speed while rough surface and low quality appear under high speed. The electronic cam function offered by DVP-PM and DVP-MC is able to generate dynamic cam curves for rotary cutting to ensure precise cutting results.



Digital Board Cutting Machine

The DVP-PM Series' built-in flying shear function is able to complete synchronous conveyance and cutting speed, and ensures precise cutting results on conveyor belts.

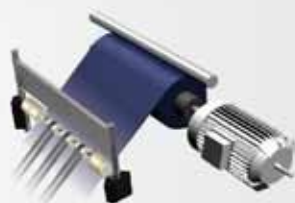

CNC Lathe

The DVP-PM Series controls multi-axis motion. Two axes complete the motion by linear or arc interpolation, and the other two work independently, controlling the independent or synchronous ascending / descending of the vertical axis on two sides.



High Performance PLC DVP-EH Series and Extension Modules

Small PLC with Highest Operation Efficiency

DVP-EH3

- ▶ Max. 512 I/O points
- ▶ 200 kHz high-speed pulse output
- ▶ High-speed extension modules
- ▶ Linear/Arc interpolation
- ▶ L type, supports extension modules (left-side)



Function Cards

- RS-232/RS-422/RS-485 Communication (COM3 Port, DVP-EH3 series PLC only)

DVP-F232



DVP-F422



DVP-F485



- Ethernet Communication

DVP-FEN01 (DVP-EH3 only)



- Analog I/O

DVP-F2AD
DVP-F2DA



Accessories

- Data Backup Card

DVP-512FM (DVP-EH3 only)



DVPPCC01
(for general applications)



- Data Transmission Cable

UC-MS030-01A



Model Name	Specifications
DVP16EH00R3	2 counters of 200 kHz input
DVP16EH00T3	2 counters of 200 kHz input, 2 axes of 200 kHz output
DVP20EH00R3	2 counters of 200 kHz input, 1 counter of 20 kHz input
DVP20EH00T3	2 counters of 200 kHz input, 2 axes of 200 kHz output
DVP32EH00R3	4 counters of 200 kHz input
DVP32EH00T3 ^{*2}	4 counters of 200 kHz input, 4 axes of 200 kHz output
DVP32EH00M3	4 counters of 200 kHz input (Differential: 2 sets), 2 axes of 200 kHz output (Differential: 2 axes)
DVP32EH00MT New	4 counters of 200 kHz input (Differential: 2 sets), 2 axes of 200 kHz output (Differential: 2 axes)
DVP32EH00R3-L ^{*1}	4 counters of 200 kHz input
DVP32EH00T3-L ^{*1*2}	4 counters of 200 kHz input, 4 axes of 200 kHz output
DVP40EH00R3	4 counters of 200 kHz input
DVP40EH00T3	4 counters of 200 kHz input, 4 axes of 200 kHz output
DVP48EH00R3	4 counters of 200 kHz input
DVP48EH00T3	4 counters of 200 kHz input, 4 axes of 200 kHz output
DVP64EH00R3	4 counters of 200 kHz input
DVP64EH00T3	4 counters of 200 kHz input, 4 axes of 200 kHz output
DVP80EH00R3	4 counters of 200 kHz input
DVP80EH00T3	4 counters of 200 kHz input, 4 axes of 200 kHz output

AC power supply Inputs Outputs Relay output Transistor output Differential output

*1 Supports high-speed extension (left-side).

*2 DVP32EH Series produced after 2014 support 4 axes of 200kHz output

Digital I/O Modules

Input Point Extension

DVP08HM11N
DVP16HM11N
DVP32HM11N



Output Point Extension

DVP08HN11R/T
DVP32HN00R/T



Input/Output Point Extension

DVP08HP11R/T
DVP16HP11R/T
DVP32HP00R/T
DVP48HP00R/T



Analog I/O Modules

Analog Function Extension

Analog Input

- DVP04AD-H2
V: 14-bit
I: 13-bit
- DVP04AD-H3
V: 16-bit
I: 16-bit



Analog Output

- DVP04DA-H2
V: 12-bit
I: 12-bit
- DVP04DA-H3
V: 16-bit
I: 16-bit



Analog Input/Output

- DVP06XA-H2
Input 4CH/Output 2CH
V: 12-bit/V : 12-bit
I: 11-bit/I : 12-bit
- DVP06XA-H3
V: 16-bit
I: 16-bit



Temperature Measurement

Sensor: Pt100

- DVP04PT-H2



Sensor:

- DVP04TC-H2
J, K, R, S, E, N, T
thermocouple
0 ~ 150mV
- DVP08TC-H2
J, K, R, S, E, N, T
thermocouple
±150mV



DVP32EH00R3-L & DVP32EH00T3-L: compatible with DVP-SV Series' high-speed extension modules (left-side)

Motion Control

Single-Axis Positioning

- DVP01PU-H2



High-Speed Counter

- DVP01HC-H2



Standard PLC DVP-ES2 / EX2 Series and Extension Modules

The Most Profitable Solution for Sequential Control



reddot design award
winner 2010

DVP-ES2/EX2

- ▶ 100 kHz pulse output
- ▶ Analog input/output



Model Name	Specifications
DVP16ES200R	⊖ 8 8 (R) →
DVP16ES200T	⊖ 8 8 (T) →
DVP20ES200RE <small>New</small>	⊖ 12 8 (R) → E
DVP20ES200TE <small>New</small>	⊖ 12 8 (T) → E
DVP24ES200R	⊖ 16 8 (R) →
DVP24ES200T	⊖ 16 8 (T) →
DVP32ES200R	⊖ 16 16 (R) →
DVP32ES200T	⊖ 16 16 (T) →
DVP32ES211T	⊖ 16 16 (T) →
DVP32ES200RC	⊖ 16 16 (R) → C
DVP32ES200TC	⊖ 16 16 (T) → C
DVP32ES200RE <small>New</small>	⊖ 16 16 (R) → E
DVP32ES200TE <small>New</small>	⊖ 16 16 (T) → E
DVP40ES200R	⊖ 24 16 (R) →
DVP40ES200T	⊖ 24 16 (T) →
DVP40ES200RE <small>New</small>	⊖ 24 16 (R) → E
DVP40ES200TE <small>New</small>	⊖ 24 16 (T) → E
DVP60ES200R	⊖ 36 24 (R) →
DVP60ES200T	⊖ 36 24 (T) →
DVP60ES200RE <small>New</small>	⊖ 36 24 (R) → E
DVP60ES200TE <small>New</small>	⊖ 36 24 (T) → E
DVP80ES200R <small>New</small>	⊖ 40 40 (R) →
DVP80ES200T <small>New</small>	⊖ 40 40 (T) →

- ⊖ AC power supply
- ↶ Inputs
- ↷ Outputs
- (T) Transistor output
- (R) Relay output
- E Ethernet
- C CANopen
- ⊖ DC power supply

DVP-EX2

Model Name	Specifications
DVP20EX200R	⊖ 8 6 (R) → 4AI/2AO
DVP20EX200T	⊖ 8 6 (T) → 4AI/2AO
DVP30EX200R	⊖ 16 10 (R) → 3AI/1AO
DVP30EX200T	⊖ 16 10 (T) → 3AI/1AO

- ⊖ AC power supply
- ↶ Inputs
- ↷ Outputs
- (T) Transistor output
- (R) Relay output
- ⊖ DC power supply

Digital I/O Modules

Input Point Extension

DVP08XM211N
DVP16XM211N

Output Point Extension

DVP08XN211R/T
DVP16XN211R/T
DVP24XN200R/T

Input/Output Point Extension

DVP08XP211R/T
DVP16XP211R/T
DVP24XP200R/T
DVP32XP200R/T



Analog I/O Modules

Input Point Extension

DVP04AD-E2

Output Point Extension

DVP04DA-E2
DVP02DA-E2

Input/Output Point Extension

DVP06XA-E2



Temperature Measurement Modules

DVP04PT-E2

DVP04TC-E2



Resolver Modules

DVP10RC-E2^{*1}



DVP-ES2 Series Extension Cable Modules

DVPAEXT01-E2



*1. Contact your sales representative for the official launch date of the DVP10RC-E2 module.

Slim PLC DVP-S Series

Compact, Flexible Extension

DVP-SS2

Standard Slim PLC



Model Name	Specifications
DVP28SS211R New	—DC— 16 Inputs 12 Outputs (R)
DVP28SS211T New	—DC— 16 Inputs 12 Outputs (T)
DVP14SS211R	—DC— 8 Inputs 6 Outputs (R)
DVP14SS211T	—DC— 8 Inputs 6 Outputs (T)
DVP12SS211S	—DC— 8 Inputs 4 Outputs (S)

—DC— DC power supply ↻ Inputs ↶ Outputs
 (T) Transistor output (NPN) (R) Relay output
 (S) Transistor output (PNP)

DVP-SX2

Analog I/O Slim PLC



Model Name	Specifications
DVP20SX211R	—DC— 8 Inputs 6 Outputs (R) 4AI/2AO
DVP20SX211T	—DC— 8 Inputs 6 Outputs (T) 4AI/2AO
DVP20SX211S	—DC— 8 Inputs 6 Outputs (S) 4AI/2AO

—DC— DC power supply ↻ Inputs ↶ Outputs
 (T) Transistor output (NPN) (R) Relay output
 (S) Transistor output (PNP)

DVP-SA2

Advanced Slim PLC



Model Name	Specifications
DVP28SA211R New	—DC— 16 Inputs 12 Outputs (R)
DVP28SA211T New	—DC— 16 Inputs 12 Outputs (T)
DVP12SA211R	—DC— 8 Inputs 4 Outputs (R)
DVP12SA211T	—DC— 8 Inputs 4 Outputs (T)

*1 The DVP28SA2 models do not support left-side modules.

—DC— DC power supply ↻ Inputs ↶ Outputs
 (T) Transistor output (NPN) (R) Relay output

DVP-SV2

High Performance Slim PLC



Model Name	Specifications
DVP28SV11R2	—DC— 16 Inputs 12 Outputs (R)
DVP28SV11T2	—DC— 16 Inputs 12 Outputs (T)
DVP28SV11S2	—DC— 16 Inputs 12 Outputs (S)
DVP24SV11T2	—DC— 10 Inputs 12 Outputs (T) 2AI

—DC— DC power supply ↻ Inputs ↶ Outputs
 (T) Transistor output (NPN) (R) Relay output
 (S) Transistor output (PNP)

DVP-SE

Network Type Advanced Slim PLC



Model Name	Specifications
DVP26SE11R New	—DC— 14 Inputs 12 Outputs (R)
DVP26SE11T New	—DC— 14 Inputs 12 Outputs (T)
DVP12SE11R	—DC— 8 Inputs 4 Outputs (R)
DVP12SE11T	—DC— 8 Inputs 4 Outputs (T)

—DC— DC power supply ↻ Inputs ↶ Outputs
 (T) Transistor output (NPN) (R) Relay output

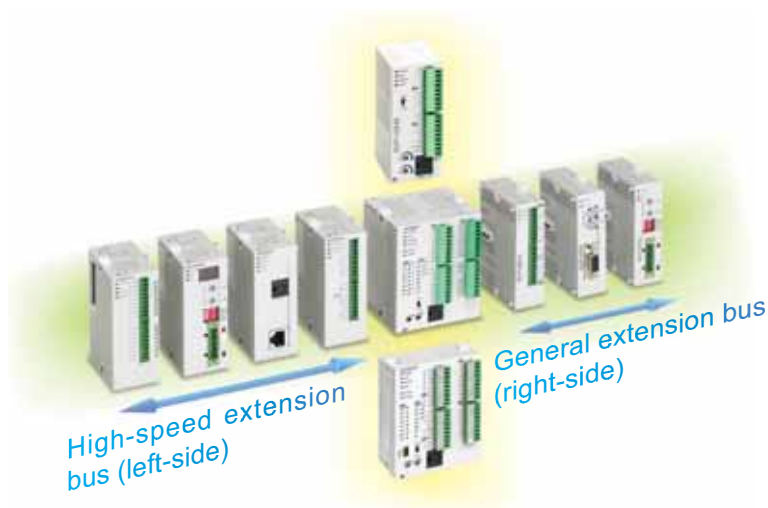

Slim PLC DVP-S Series Extension Modules

High-speed Extension Modules (left-side)¹

Network Modules

- **DeviceNet Master**
DVDPNET-SL
- **CANopen Master**
DVPCOPM-SL



- **Ethernet**
DVPEN01-SL



- **PROFIBUS-DP Slave**
DVPPF02-SL

- **RS-422/RS-485 Serial Communication Module**
DVPSCM12-SL



- **BACnet MS/TP Slave Serial Communication Module**

Analog Extension

- **Analog Input**
DVP04AD-SL
- **Analog Output**
DVP04DA-SL



Load Cell/Tension

- **Load Cell Module**
DVP01LC-SL
DVP02LC-SL
DVP201LC-SL
DVP211LC-SL
DVP202LC-SL



General Extension Modules (right-side)²

I/O Point Extension

- **Input Point Extension**
DVP08SM11N
DVP16SM11N

- **Output Point Extension**
DVP06SN11R
DVP08SN11R/T
DVP08SN11TS
DVP16SN11T
DVP16SN11TS

- **Input/Output Point Extension**
DVP08SP11R/T
DVP08SP11TS
DVP16SP11R/T
DVP16SP11TS



- **Pin Header Input**
DVP32SM11N

- **Pin Header Output**
DVP32SN11TN

- **Digital Switch**
DVP08ST11N



Analog Extension

- **Analog Input**
DVP04AD-S
DVP06AD-S
DVP04AD-S2

- **Analog Output**
DVP04DA-S
DVP02DA-S
DVP04DA-S2

- **Analog Input/Output**
DVP06XA-S
DVP06XA-S2



Temperature Measurement

- **Sensor: Pt100, Pt1000**
DVP04PT-S
DVP06PT-S

- **Sensor: J,K,R,S,T thermocouple**
DVP04TC-S

- **Temperature Control:** New
DVP02TUN-S
DVP02TUR-S
DVP02TUL-S

- **Remote Temperature Control Module:** New
DVP02TKN-S
DVP02TKR-S
DVP02TKL-S



Communication Modules

- **PROFIBUS Slave**
DVPPF01-S

- **DeviceNet Slave**
DVPDT01-S

Power Supply Modules

- DVPPS01
DVPPS02
DVPPS05

Axis Control Module

- **Single-Axis Positioning**
DVP01PU-S



*1. DVP32EH00R3-L & DVP32EH00T3-L are also compatible with the left-side high-speed extension modules.

*2. Max. quantity of right-side extension module is 14, among which the quantity of -S and -S2 modules must be equal to or less than 8. If the total quantity of extension modules is over 14, applying high density extension modules is recommended.

Specifications

Electrical Specifications

	AC	DC
Power Supply Voltage	100~240 V _{AC} (-15%~10%), 50/60Hz ±5%	24 V _{DC} (-15%~20%)
Fuse Capacity	2A/250 V _{AC}	ES: 2A/250 V _{AC} ; SV: 2.5A/30 V _{DC}
Spike Voltage Durability	1500 V _{AC} (Primary-secondary); 1500 V _{AC} (Primary-PE); 500 V _{AC} (Secondary-PE)	
Insulation Impedance	>5MΩ (all I/O point-to-ground: 500V _{DC})	
Noise Immunity	ESD: 8 kV Air Discharge EFT: Power Line, 2 kV Digital I/O: 1 kV Analog & Communication I/O: 1 kV RS: 26MHz~1 GHz, 10V/m	
Earth	The diameter of grounding wire shall not be shorter than that of the power supply cable. (When many PLCs are in use at the same time, please make sure every PLC is properly grounded.)	
Storage/Operation	Storage: -25°C~70°C (temperature); 5%~95% (humidity) Operation: 0°C~55°C (temperature); 5%~95% (humidity); pollution degree 2	

Input Specifications^{*1}

Max. Input Frequency	10 kHz	20 kHz	100 kHz	200 kHz	
Input Signal Type	NPN (Sink)/PNP (Source)				
Input Signal Voltage	24 V _{DC} ±10% (5mA)				
Response time^{*2}	DVP-EH3/SV2/PM	OFF→ON: 20 μs ON→OFF: 50 μs	ES/EX/SX/SS2/SX2 OFF→ON: 3.5 μs ON→OFF: 20 μs	ES2/EX2/SA2/SX2 OFF ON: 2.5 μs ON→OFF: 5 μs	EH3/SV2/PM OFF→ON: 0.15 μs ON→OFF: 3 μs
	DVP-ES2/EX2				
	DVP-ES/EX				
	DVP-SX				
	DVP-SS2				
	DVP-SA2/SX2/SE				

*1. For more detailed specifications, see the "Specification" section in the instruction sheet of each model.

*2. When the input point on PLC conducts only general input functions, use D1020 or D1021 to adjust the response time (default: 10ms).

Output Specifications^{*1}

	Relay-R	Transistor-T		
		General speed	High speed	
Max. Exchange (working) Frequency	1Hz ^{*2}	10 kHz	100 kHz	200 kHz
Current spec.	DVP-EH3/SV2/PM	0.3A/point @40°C	SA2/SX2/ES2/EX2/SE Resistive: 0.5A/point (4A/COM) Conductive: 12W (24 V _{DC}) Light bulb: 2W (24 V _{DC})	EH3/SV2/PM Resistive: 0.5A/point (4A/COM) Conductive: 12W (24 V _{DC}) Light bulb: 2W (24 V _{DC})
	DVP-ES2/EX2			
	DVP-ES/EX			
	DVP-SX			
	DVP-SS2/SA2/SX2/SE			
Voltage Spec.	250 V _{AC} /30 V _{DC}	30 V _{DC}		
Response Time	10ms	OFF→ON: 20 μs ON→OFF: 30 μs	OFF→ON: 2 μs ON→OFF: 3 μs	OFF→ON: 0.5 μs ON→OFF: 2.5 μs

*1. For more detailed specifications, see the "Specification" section in the instruction sheet of each model.

*2. Relay life: Resistive load more than 200,000 times; conductive load more than 80,000 times.

DVP-EH3 Series

Model Name (mm)	H	H1	W	W1	W2
DVP16EH00R3 / T3	90	80	113	103	82
DVP20EH00R3/T3	90	80	113	103	82
DVP32EH00M3/MT	90	80	143.5	133.5	82
DVP32EH00R3/T3	90	80	143.5	133.5	82
DVP32EH00R3-L	90	80	143.5	133.5	82
DVP32EH00T3-L	90	80	143.5	133.5	82
DVP40EH00R3/T3	90	80	158.8	153.8	82
DVP48EH00R3/T3	90	80	174	164	82
DVP64EH00R3/T3	90	80	212	202	82
DVP80EH00R3/T3	90	80	276	266	82

*The dimensions of the DVP-EH3 and DVP-EH2 Series are the same.

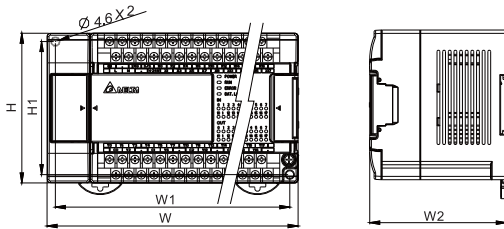

DVP-SV / SX2 / MC Series

Model Name (mm)	H	H1	W	W1
DVP28SV11R2/T2	60	90	70	53.2
DVP20SX211R/T/S	60	90	70	53.2
DVP10MC11T	60	90	70	53.2

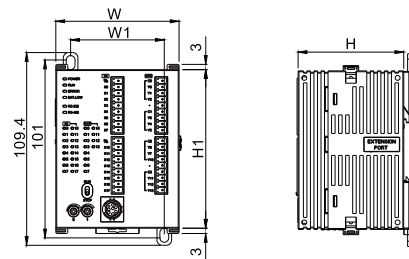

Model Name (mm)	H	H1	W	W1
DVP15MC11T	110	116.2	128	68.4
DVP15MC11T-06	110	116.2	128	68.4
DVP50MC11T	110	116.2	128	68.4
DVP50MC11T-06	110	116.2	128	68.4

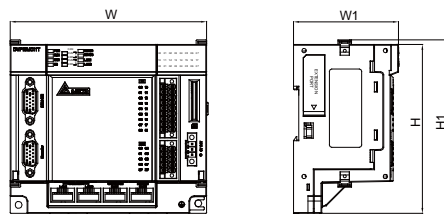

DVP-EH3 Series I/O & Extension Modules

Model Name (mm)	H	H1	W	W1	W2
DVP08HM11N	90	80	40	36	82
DVP16HM11N	90	80	55	51	82
DVP32HM11N	90	80	143.5	133.5	82.2
DVP08HN11R/T	90	80	40	36	82
DVP32HN00R/T	90	80	143.5	133.5	82.2
DVP08HP11R/T	90	80	40	36	82
DVP16HP11R/T	90	80	55	51	82
DVP32HP00R/T	90	80	143.5	133.5	82.2
DVP48HP00R/T	90	80	174	164	82.2

Model Name (mm)	H	H1	W	W1	W2
DVP04AD-H2	90	80	60	56	82
DVP04DA-H2	90	80	60	56	82
DVP06XA-H2	90	80	60	56	82
DVP04PT-H2	90	80	60	56	82
DVP04TC-H2	90	80	60	56	82
DVP01PU-H2	90	80	60	56	82
DVPDT02-H2	90	80	40	46	82
DVPCP02-H2	90	80	40	46	82
DVPPF02-H2	90	80	40	46	82
DVP04AD-H3	90	80	60	56	82
DVP04DA-H3	90	80	60	56	82
DVP06XA-H3	90	80	60	56	82

*The dimensions of the DVP-EH3 and DVP-EH2 Series are the same.

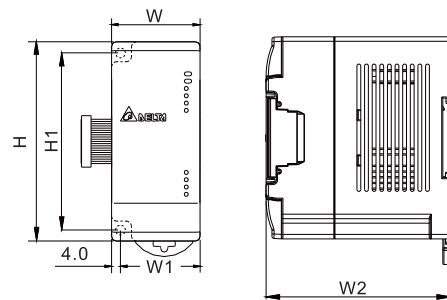

DVP-SE / SX / SS2 / SA2 Series

Model Name (mm)	H	H1	W	W1
DVP28SS211R/T	96	90	46	60
DVP28SA211R/T	96	90	46	60
DVP26SE11R/T	96	90	46	60
DVP14SS211R/T	96	90	25.2	60
DVP12SS211S	96	90	25.2	60
DVP12SA211R/T	96	90	37.4	60
DVP12SE11R/T	96	90	37.4	60
DVP10SX11R/T	96	90	37.4	60

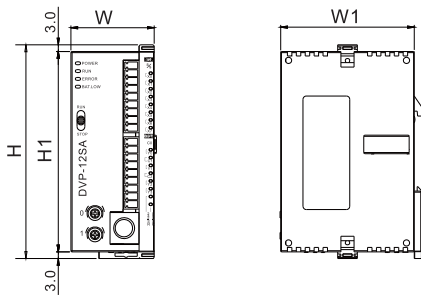

High-Speed Extension Modules (left-side)

Model Name (mm)	H	H1	W	W1
DVPEN01-SL	96	90	33.1	60
DVPCOPM-SL	96	90	33.1	60
DVPDNET-SL	96	90	33.1	60
DVPPF02-SL	96	90	33.1	60
DVPSCM12-SL	96	90	33.1	60
DVPSCM52-SL	96	90	33.1	60
DVP04AD-SL	96	90	33.1	60
DVP04DA-SL	96	90	33.1	60
DVP01LC-SL	96	90	33.1	60
DVP02LC-SL	96	90	33.1	60
DVP201LC-SL	96	90	33.1	60
DVP202LC-SL	96	90	33.1	60
DVP211LC-SL	96	90	33.1	60

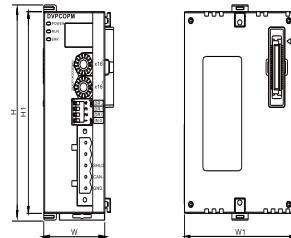

Remote I/O Modules

Model Name (mm)	H	H1	W	W1
RTU-DNET	96	90	25.2	60
RTU-485	96	90	25.2	60
RTU-EN01	96	90	25.2	60
RTU-PD01	96	90	25.2	60

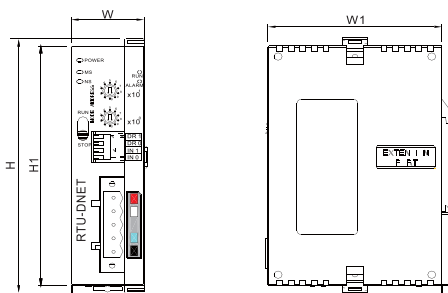

Remote Temperature Control Modules

Model Name (mm)	H	H1	W	W1
DVP02TKN-S	96	90	25.2	60
DVP02TKR-S	96	90	25.2	60
DVP02TKL-S	96	90	25.2	60

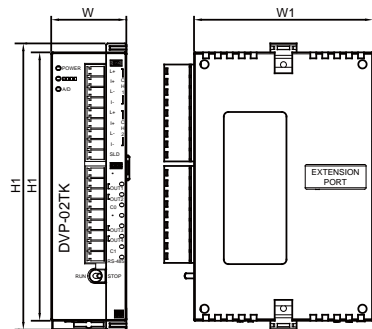

DVP-PS01/02 Power Supply Modules

Model Name (mm)	H	H1	W	W1
DVPPS01	100	90	36.5	60
DVPPS02	100	90	55	60

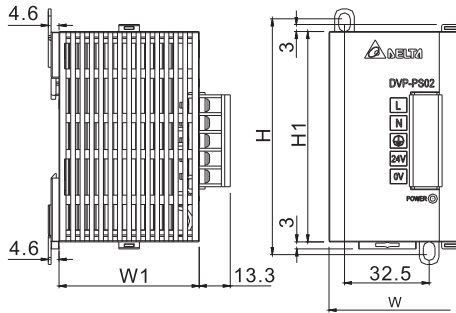

DVP-PS05 Power Supply Modules

Model Name (mm)	H	H1	W	W1
DVPPS05	93.3	90	60	63.4

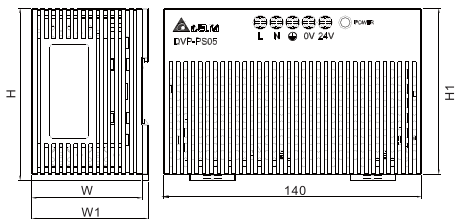

PIN Definition of UC-MS030-01A

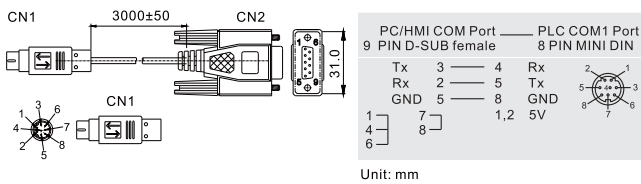

DVP-S Series I/O and Extension Modules

Model Name (mm)	H	H1	W	W1
DVP08SM11N	96	90	25.2	60
DVP16SM11N	96	90	25.2	60
DVP06SN11R	96	90	25.2	60
DVP08SN11R/T/TS	96	90	25.2	60
DVP08SP11R/T/TS	96	90	25.2	60
DVP16SP11R/T/TS	96	90	25.2	60
DVP16SN11T	96	90	25.2	60
DVP16SN11TS	96	90	25.2	60
DVP04AD-S	96	90	25.2	60
DVP04AD-S2	96	90	25.2	60
DVP06AD-S	96	90	25.2	60
DVP02DA-S	96	90	25.2	60
DVP04DA-S	96	90	25.2	60
DVP04DA-S2	96	90	25.2	60
DVP06XA-S	96	90	25.2	60
DVP06XA-S2	96	90	25.2	60
DVP04PT-S	96	90	25.2	60
DVP06PT-S	96	90	25.2	60
DVP04TC-S	96	90	25.2	60
DVP01PU-S	96	90	25.2	60
DVPPF01-S	96	90	25.2	60
DVPDT01-S	96	90	25.2	60
DVP02TUN-S	96	90	25.2	60
DVP02TUR-S	96	90	25.2	60
DVP02TUL-S	96	90	25.2	60

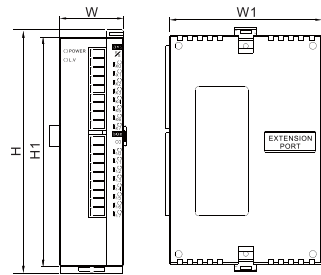

Model Name (mm)	H	H1	W	W1
DVP32SN11TN	96	90	25.2	60
DVP32SM11N	96	90	25.2	60

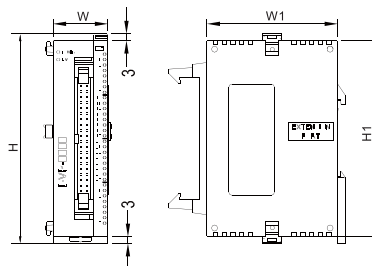

PLC Editing Software: I SPSoft V2.0

Highly Accessible Programming Software with Fully Integrated Interface

Advanced Programming Interface + Visualized Hardware Configuration + Simplified Network Configuration

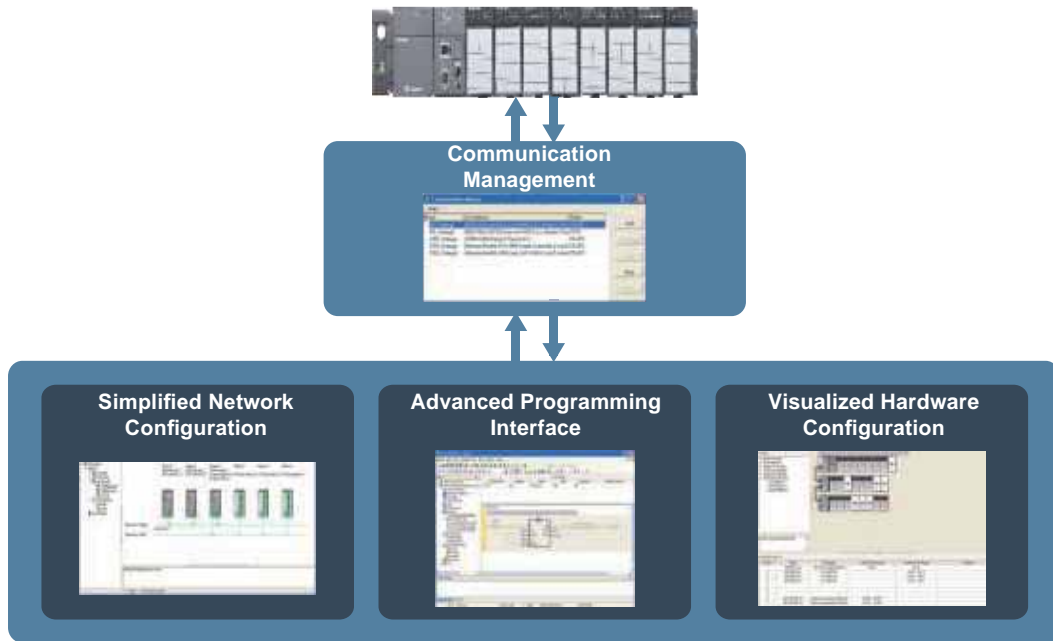

Advanced Programming Interface

Project Management Window

- **New functions:** Network configuration (NWCONFIG), hardware configuration (HWCONFIG) and PLC card utility
- 5 programming languages for programs and function blocks (FB): LD/FBD/SFC/IL/ST
- **Function Blocks:** Symbols can be introduced in call-by-value or call-by-reference types. Function blocks can be called in a function block for up to 32 levels
- **Monitor Table:** It can be stored and managed separately. Multiple monitor tables can be stored in a single project
- **User Library:** Users can design frequently used instructions for specific applications in different industries
- **Task:** Supports cyclic, I/O interrupt, timer interrupt, external interrupt, and more. Software will provide the usable tasks for different CPUs
- Built-in Delta Function Blocks provide a convenient programming environment for operators

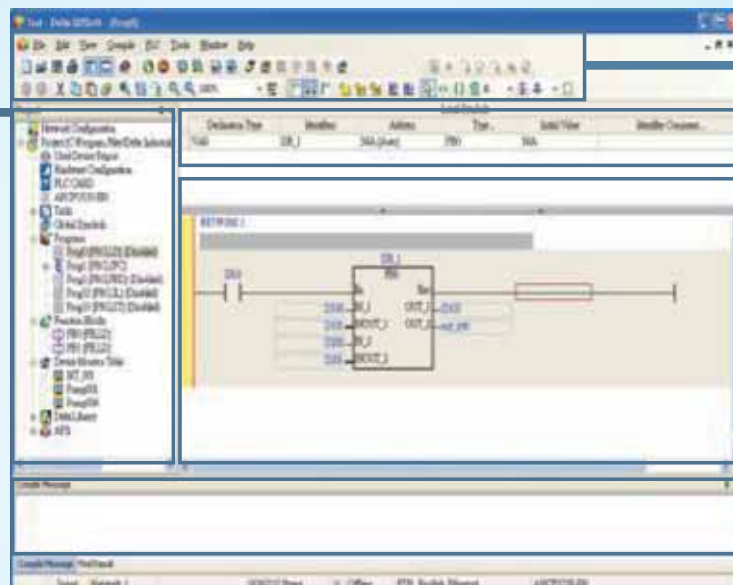

- **Toolbar**
- **Symbol Table**
- **Program Editing Area**
- **Message Window**

Visualized Hardware Configuration

Module Selection

Module Description

Toolbar

- System hardware configuration can be monitored in On-Line mode
- Hardware configuration can be displayed by Scan function

Hardware Configuration Area

- Operations of Cut/Copy/Paste/Delete are available for modules and racks
- Parameters of each module can be directly configured

Rack Information

- I/O device range can be specified by the user

Slot No.	Mount	Description	Input Device Range	Output Device Range	Comment
0	ARM200-SA	All Power Supply Module	None	None	
1	ARM200-SA	All base CPU Module	None	None	
2	ARM200-SA	32 x DI, 16 VDC	2010 - 2010	None	
3	ARM200-SA	32 x DO, NPN 0.5A, 24 VDC	2010 - 2010	Y010 - Y010	
4	ARM200-SA	8 x AI 12 Bit	D00 - D00	None	
5	ARM200-SA	8 x AO 12 Bit	D00 - D00	200 - 200	
6	ARM200-SA	8 x AI 12 Bit	2010 - 2010	None	
7	ARM200-SA	8 x AO 12 Bit	2010 - 2010	2010 - 2010	

Simplified Network Configuration

192.168.1.11 Station 11

192.168.1.12 Station 12

192.168.1.13 Station 13

Ethernet

RS-485

Station 21 Station 22 Station 23

FMCS

Network Device Selection

Toolbar

Network Configuration Area

- Master device settings
- Ether Link editing function
- PLC Link editing function

Network Information

Ether Link

PLC Link

4-Line Text Panel HMI

TP04G-AL-C

TP04G-AL2

- ▶ 4.1" STN-LCD
- ▶ User-defined function keys available
- ▶ Supports RS-232/RS-422/RS-485 ports (TP04G-AL2)
- ▶ Password protection function available
- ▶ User-defined boot screen available
- ▶ Built-in real time clock (RTC)

Dimensions	4.1" (101.8 × 35.24 mm)
Resolution	192 × 64
Display Color	Monochrome
Flash Memory	256k bytes
Function Key	10 function keys
Password	Available
Recipe Function	Not available
RTC	Available
Serial COM Port	RS-232 & RS-422/485
Editing Software	TPEditor

4-Line Text Panel HMI

TP04G-BL-C

- ▶ 4.1" STN-LCD
- ▶ 0~9 numeric keys and user-defined function available
- ▶ Built-in RS-232 and RS-422/RS-485 ports
- ▶ Supports MODBUS ASCII/RTU modes
- ▶ Password protection function available
- ▶ User-defined boot screen available
- ▶ Built-in real time clock (RTC)

Dimensions	4.1" (101.8 × 35.24 mm)
Resolution	192 × 64
Display Color	Monochrome
Flash Memory	256k bytes
Function Key	17 function keys
Password	Available
Recipe Function	Not available
RTC	Available
Serial COM Port	RS-232 & RS-422/485
Editing Software	TPEditor

8-Line Text Panel HMI

TP08G-BT2

- ▶ 3.8" STN-LCD
- ▶ Resolution: 240 x 128 dots
- ▶ Built-in 1,024KB flash memory
- ▶ 24 user-defined function keys
- ▶ Built-in RS-232 and RS-422/RS-485 ports
- ▶ Supports recipes and macro functions

Dimensions	3.8" (83 x 41 mm)
Resolution	240 × 128
Display Color	Monochrome
Flash Memory	1 M bytes
Function Key	24 function keys
Password	Available
Recipe Function	Available
RTC	Available
Serial COM Port	RS-232 & RS-422/485
Editing Software	TPEditor

Applications

Intelligent control systems for aquaculture, steel sleeve tapping machines, air compressors, plant factories

7-Inch Touch Panel HMI with Built-in PLC

TP70P-RM0

- ▶ Adopts the core of the DVP-SS2 Series PLC: program capacity: 2k steps / D device: 5k words
- ▶ 7" TFT-LCD
- ▶ Touch screen
- ▶ Built-in USB port for program upload/download
- ▶ Built-in RS-232 and RS-485 ports
- ▶ Supports MODBUS ASCII/RTU modes
- ▶ Built-in real time clock (RTC)

Dimensions	7" (154 × 85 mm)
Resolution	800 × 480
Display Color	65,535 colors
Flash Memory	64 M bytes
Function Key	Not available
Password	Available
Recipe Function	Not available
RTC	Available
Serial COM Port	RS-232 & RS-485
Editing Software	TPEditor

7-Inch Touch Panel HMI with Built-in PLC

TP70P

- ▶ Adopts the core of the DVP-SS2 Series PLC: program capacity: 4k steps / D device: 5k words
- ▶ Provides 2 sets of 10kHz high-speed pulse input
- ▶ 7" TFT-LCD
- ▶ Touch screen
- ▶ Built-in USB port for program upload/download
- ▶ Built-in RS-485 port*2
- ▶ Supports MODBUS ASCII/RTU modes
- ▶ Built-in real time clock (RTC)
- ▶ Digital and analog I/O terminals available

Dimensions	7" (154 × 85 mm)
Resolution	800 × 480
Display Color	65,535 colors
Flash Memory	64 M bytes
Function Key	Not available
Password	Available
Recipe Function	Not available
RTC	Available
Serial COM Port	2 sets of RS-485
Editing Software	TPEditor

4-Line Text Panel HMI with Built-in PLC

TP04P

- ▶ Adopts the core of the DVP-SS2 Series PLC: program capacity: 8k steps / D device: 5k words
- ▶ Provides 2 sets of 10kHz high-speed pulse input (Excludes TP04P-08TP1R)
- ▶ 4.1" STN-LCD
- ▶ Provides 0~9 numeric keys with user-defined function
- ▶ Built-in USB port for program upload/download
- ▶ Built-in RS-485 port*2
- ▶ Supports MODBUS ASCII/RTU modes
- ▶ User-defined boot screen available
- ▶ Built-in real time clock (RTC)
- ▶ Digital and analog I/O terminals available

Dimensions	4.1" (101.8 × 35.24 mm)
Resolution	192 × 64
Display Color	Monochrome
Flash Memory	1 M bytes
Function Key	17 function keys
Password	Available
Recipe Function	Not available
RTC	Available
Serial COM Port	2 sets for RS-485
Editing Software	TPEditor

		Text Panel HMI					Text/Touch Panel HMI with Built-in PLC			
Model		TP02G-AS1	TP04G-AS2	TP08G-BT2	TP04G-AL-C	TP04G-AL2	TP04G-BL-C	TP04P-Series	TP04P-08TP1R	TP70P-Series
Display Specifications	Screen Type	STN-LCD							TFT-LCD	
	Display Color	Monochrome							65,535	
	Resolution	160 x 32	128 x 64	240 x 128	192 x 64			800 x 480		
	Backlight	Life span of backlight is about 50,000 hours at 25°C							20,000 hours	
	Display Range	72 x 22mm	3" (67 x 32mm)	3.8" (83 x 41mm)	4.1" (101.8 x 35.24mm)			7" (154 x 85mm)		
Flash Memory	256k bytes		1M bytes	256k bytes			1M bytes		64M bytes	
Program Download Port	COM1 (RS-232)						COM1 (USB)		USB	
Serial COM Port	COM1	RS-232	RS-232/422		RS-232	RS-232/422	RS-232	-		-
	COM2	RS-485			-	RS-422/485	RS-422/485	RS-485		TP70 with I/O: RS-485 TP70R-RM0: RS-232
	COM3	-			-	-	-	RS-485		
Extension Interface	The slot for program copy card								-	
Real-time Clock	-	Built-in								
Auxiliary Keys	System Keys	6	7	12	5		7		5	-
	Function Keys	10	5	12	5		10		5	-
Operating Voltage	+24 V _{DC} (-10% ~ +20%)									
Backup Battery	3V lithium battery CR2032 x 1/battery life: 5 years									
Buzzer	85 dB									
Cooling Method	Natural air circulation									
Operating Temperature	0°C~50°C									
Storage Temperature	-20°C~+60°C									
Operating Humidity	10%~90% RH (0~40°C)									
Vibration	IEC 61131-2, IEC 68-2-6 (TEST Fc); 5 Hz ≤ f < 8.4 Hz Continuous: 3.5 mm; 8.4 Hz ≤ f ≤ 150 Hz Continuous: 1.0 g									
Shock	IEC 61131-2, IEC 68-2-27 (TEST Ea); 15g peak, 11ms duration, half-sine, three shocks in each direction per axis, on 3 mutually perpendicular axes (total of 18 shocks)									
Radiated Emission	CISPR11, Class A Frequency: 30~230 MHz, Limits: 40 dB uV/m Frequency: 230 MHz~1 GHz, Limits: 47 dB uV/m									
Radiated Electromagnetic Field	EN61000-4-3, Frequency: 80~2000 MHz, Limits: 10V/m									
Electrostatic Discharge	EN61000-4-2, Air Discharge: 8 KV, Contact Discharge: 4 KV									
Fast Transient Burst	EN61000-4-4, Power Line: 1 KV, Communication I/O: 500 V									
Dimensions Width (W) × Height (H) × Depth (D)	147 x 97 x 35.5		210 x 122 x 45		163.6 x 108.6 x 37		175.8 x 108.8 x 37		TP04P Series: 175.8 x 108.6 x 59.2 TP04P-20EXL1T: 175.8 x 108.6 x 82.4 TP70P Series: 205.6 x 142.6 x 49 TP70P-RM0: 205.6 x 142.6 x 37 TP70P-211LC1T: 205.6 x 142.6 x 87.7	
Panel Cutout	136 x 85		196 x 108		151 x 96		163 x 96		191 x 128	
Weight	240 g		430 g		268 g		270 g		TP04P Series: 500 g TP04P-20EXL1T: 650 g TP70P Series: 680 g TP70P-RM0: 620 g TP70P-211LC1T: 900 g	
Safety Approvals (Waterproof Class of Front Panel)	IP65/NEMA4 & CE, UL Type 4 indoor				IP65/NEMA4 & CE, UL					
Editing Software	TPEditor V1.87									

Product Outline and Dimensions

Unit: mm

TP02G-AS1	TP04G-AS2	TP04G-AL-C/TP04G-AL2	TP04G-BL-C
<p>Front view: 147 x 97 Top view: 135 x 40.5 Side view: 85</p>	<p>Front view: 147 x 97 Top view: 135 x 40.5 Side view: 85</p>	<p>Front view: 163.6 x 108.6 Top view: 150 x 37 Side view: 95</p>	<p>Front view: 175.8 x 108.6 Top view: 162.2 x 37 Side view: 95</p>
TP04P-Series (Exclude TP04P-08TP1R, TP04P-20EXL1T)	TP08G-BT2	TP70P-Series (Exclude TP70P-RM0, TP70P-211LC1T)	TP70P-RM0
<p>Front view: 175.8 x 108.6 Top view: 162.2 x 59.2 Side view: 95</p>	<p>Front view: 210 x 122 Top view: 196.26 x 37.5 Side view: 108.26</p>	<p>Front view: 205.6 x 142.6 Top view: 189.6 x 49 Side view: 126.6</p>	<p>Front view: 205.6 x 142.6 Top view: 189.6 x 37 Side view: 126.6</p>
TP04P-08TP1R	TP04P-20EXL1T	TP70P-211LC1T	
<p>Front view: 175.8 x 108.6 Top view: 163 x 37 Side view: 96</p>	<p>Front view: 175.8 x 108.6 Top view: 163 x 82.4 Side view: 96</p>	<p>Front view: 205.6 x 142.6 Top view: 191 x 87.7 Side view: 121</p>	

DVP Series Model Name Instructions

• PLC

Series ① ② ③ ④ ⑤

- Total I/O**
- Model**
 ES/ES2: DVP-ES/ES2 series PLC
 EX/EX2: DVP-EX/EX2 series PLC
 SS/SS2: DVP-SS/SS2 series PLC
 SA/SA2: DVP-SA/SA2 series PLC
 SX/SX2: DVP-SX/SX2 series PLC
 SC: DVP-SC series PLC
 SV: DVP-SV series PLC
 SE: DVP-SE series PLC
 PM: DVP-PM series PLC
 MC: DVP-MC series PLC
 EH: DVP-EH series PLC
 EC: DVP-EC series PLC
- Power supply**
 00: AC power input
 11: DC power input
- Output type**
 R: Relay
 T: Transistor (NPN)
 M: Mixed with differential signal
 S: Transistor (PNP)
 RC: Relay + CANopen
 TC: Transistor + CANopen
 RE: Relay + Ethernet
 TE: Transistor + Ethernet
- Version**

• PI/PO Module

Series ① ② ③

- Total I/O**
- Module function**
 HC: High-speed counter
 PU: Single-axis positioning module
- Compatible model**
 S: DVP-SS/SA/SX/SC/SV/SS2/SA2/SX2/SV2/SE/MC Series PLC
 H2/H3: DVP-EH2/EH3/PM Series PLC
 SL: left-side extension for DVP-S Series PLC

• Remote I/O

Series ①

- Type**
 DNET: DeviceNet
 485: RS-485
 EN01: MODBUS TCP

• DI/DO Module

Series ① ② ③ ④ ⑤

- Total I/O**
- Model**
 X: DVP-ES/EX/ES2/EX2 series PLC
 S: DVP-SS/SA/SX/SC/SV/SS2/SA2/SX2/SV2/SE/MC series PLC
 H: DVP-EH2/EH3/PM series PLC
- I/O type**
 M: Input point
 N: Output point
 P: Input + output
- Power supply**
 00: AC power input
 11: DC power input
- Output type**
 R: Relay
 T: Transistor (NPN)
 TS: Transistor (PNP)
 N: None output

• Function Card

Series ① ② ③

- Function Card**
- Function**
 232: RS-232 card
 422: RS-422 card
 485: RS-485 card
 2AD: 2ch analog input
 2DA: 2ch analog output
- Particular definition**
 S: Slave mode
 (applicable to COM3 coding only)

• Accessory: Cable

Series ① ② ③ ④

- Accessory**
- Accessory definition**
 CAB: Cable
- Type**
 1, 2, 3, 4,
- Cable length**
 15: 1.5m
 30: 3.0m

• AI/AO Module

Series ① ② ③

- Total I/O**
- Module function**
 AD: Analog/digital conversion
 DA: Digital/analog conversion
 PT: PT type temperature module
 TC: Thermocouple type temperature Module
 XA: AD+DA module
 LC: Load cell module
 RC: Resolver module
- Compatible model**
 S or S2: DVP-SS/SA/SX/SC/SV/SS2/SA2/SX2/SV2/SE/MC Series PLC
 SL: left-side extension for DVP-S Series PLC
 E2: DVP-ES2/EX2 Series PLC

• Network Module

Series ① ②

- Module function**
 EN01: MODBUS TCP
 DNET: DeviceNet master
 COPM: CANopen master
 CP02: CANopen Slave
 DT01/02: DeviceNet Slave
 PF01/02: PROFIBUS DP Slave
- Compatible model**
 S: DVP-SS/SA/SX/SC/SV/SS2/SA2/SX2/SV2/SE/MC Series PLC
 H2/H3: DVP-EH2/EH3/PM Series PLC
 SL: left-side extension for DVP-S Series PLC

• Accessory: Other

Series ① ② ③

- Accessory**
- Accessory definition**
 Bt: Battery
- Type: 01, 02**

*For the availability of the product models, please contact Delta sales representatives or

ue.

DVP Series PLC Function Overview

Select your desired specifications and locate the most suitable PLC.



Item	Specifications	Check	Model							
			ES2	EX2	EH3	SS2	SA2	SX2	SV2	SE
Power Supply	AC	<input type="checkbox"/>	⊙	⊙	○					
	DC	<input type="checkbox"/>				○	○	○	○	○
I/O Points	< 256	<input type="checkbox"/>	△	△						
	< 512	<input type="checkbox"/>			△	△	△	△	△	△
Program Capacity	< 8k	<input type="checkbox"/>				○				
	<16k	<input type="checkbox"/>	○	○			○	○		○
	< 32k	<input type="checkbox"/>			○				○	
Output Type	Transistor (NPN)	<input type="checkbox"/>	⊙	⊙	⊙	⊙	⊙	⊙	⊙	⊙
	Transistor (PNP)	<input type="checkbox"/>				⊙	△	⊙	⊙	△
	Relay	<input type="checkbox"/>	⊙	⊙	⊙	⊙	⊙	⊙	⊙	⊙
	Differential signal	<input type="checkbox"/>			⊙					
Communication	3 COM ports (RS-232/485)	<input type="checkbox"/>	○	○	△		○	△	△	△
	Ethernet	<input type="checkbox"/>	⊙		△		△	△	△	○
	USB	<input type="checkbox"/>						○		○
	DeviceNet	<input type="checkbox"/>			△*1		△*1	△*1	△*1	△*1
	CANopen	<input type="checkbox"/>	⊙		△*1		△*1	△*1	△*1	△*1
	PROFIBUS	<input type="checkbox"/>			△*1		△*1	△*1	△*1	△*1
Positioning	2-axis output	<input type="checkbox"/>	○	○	○	○	○	○		○
	4-axis output	<input type="checkbox"/>			⊙				○	
	> 4 axes	<input type="checkbox"/>			△	△	△	△	△	△
	2-axis interpolation	<input type="checkbox"/>	○	○	○		○	○	○	○
	100 kHz high speed	<input type="checkbox"/>	○	○			○	○		○
	200 kHz high speed	<input type="checkbox"/>			○	△	△	△	○	△
High-speed Counting	≤ 2 channels	<input type="checkbox"/>	○	○		○	○	○		○
	≥ 3 channels	<input type="checkbox"/>			○*3	△	△	△	○	△
	100 kHz high speed	<input type="checkbox"/>	○	○			○	○		○
	200 kHz high speed	<input type="checkbox"/>			○	△	△	△	○	△
Analog Function	< 4 channels (AD)	<input type="checkbox"/>	△	○	△	△	△	○	△	△
	< 2 channels (DA)	<input type="checkbox"/>	△	○*2	△	△	△	○*2	△	△

Note:

○ With such specification ⊙ Varies upon model △ With such specification when connected to extension module/function card

*1: Series that support left-side modules can support both master and slave; other series support only slave

*2: DVP-EX / SX2 Series have 4 channels of analog input and 2 channels of analog output

*3: In addition to the built-in 4 channels of high-speed counters, the DVP-EH3 Series can connect high-speed counter modules

Ordering Information

DVP-EC3 Series PLC

Product Name	Power Supply	Output Method	Inputs	Outputs	Model Name	Certificates
DVP-EC3 Series Basic PLC	100~240 V _{AC}	Relay	6	4	DVP10EC00R3	
	100~240 V _{AC}	Transistor	6	4	DVP10EC00T3	
	100~240 V _{AC}	Relay	8	6	DVP14EC00R3	
	100~240 V _{AC}	Transistor	8	6	DVP14EC00T3	
	100~240 V _{AC}	Relay	8	8	DVP16EC00R3	
	100~240 V _{AC}	Transistor	8	8	DVP16EC00T3	
	100~240 V _{AC}	Relay	12	8	DVP20EC00R3	
	100~240 V _{AC}	Transistor	12	8	DVP20EC00T3	
	100~240 V _{AC}	Relay	12	12	DVP24EC00R3	
	100~240 V _{AC}	Transistor	12	12	DVP24EC00T3	
	100~240 V _{AC}	Relay	18	12	DVP30EC00R3	
	100~240 V _{AC}	Transistor	18	12	DVP30EC00T3	

DVP-EC3 Series PLC

Product Name	Power Supply	Output Method	Inputs	Outputs	Model Name	Certificates
DVP-EC3 Series Basic PLC	100~240 V _{AC}	Relay	16	16	DVP32EC00R3	
	100~240 V _{AC}	Transistor	16	16	DVP32EC00T3	
	100~240 V _{AC}	Relay	24	16	DVP40EC00R3	
	100~240 V _{AC}	Transistor	24	16	DVP40EC00T3	
	100~240 V _{AC}	Relay	28	20	DVP48EC00R3	
	100~240 V _{AC}	Transistor	28	20	DVP48EC00T3	
	100~240 V _{AC}	Relay	36	24	DVP60EC00R3	
	100~240 V _{AC}	Transistor	36	24	DVP60EC00T3	
Fastest execution time of basic instructions		3.8 μs	Execution time of MOV instruction		5.04 μs	

DVP-ES2/EX2 Series PLC

Product Name	Power Supply	Output Method	Inputs	Outputs	Model Name	Certificates
DVP-ES2 Series Standard PLC	100~240 V _{AC}	Relay	8	8	DVP16ES200R	
	100~240 V _{AC}	Transistor	8	8	DVP16ES200T	
	100~240 V _{AC}	Relay	16	8	DVP24ES200R	
	100~240 V _{AC}	Transistor	16	8	DVP24ES200T	
	100~240 V _{AC}	Relay	16	16	DVP32ES200R	
	100~240 V _{AC}	Transistor	16	16	DVP32ES200T	
	24 V _{DC}	Transistor	16	16	DVP32ES211T	
	100~240 V _{AC}	Relay	24	16	DVP40ES200R DVP40ES200RM ^{*1}	
	100~240 V _{AC}	Transistor	24	16	DVP40ES200T	
	100~240 V _{AC}	Relay	36	24	DVP60ES200R	
	100~240 V _{AC}	Transistor	36	24	DVP60ES200T	
	100~240 V _{AC}	Relay	40	40	DVP80ES200R	
100~240 V _{AC}	Transistor	40	40	DVP80ES200T		
DVP-ES2 Series Standard PLC with Built-in CANopen	100~240 V _{AC}	Relay	16	16	DVP32ES200RC	
	100~240 V _{AC}	Transistor	16	16	DVP32ES200TC	
DVP-ES2 Series ^{New} Standard PLC with Ethernet Communication	100~240 V _{AC}	Relay	12	8	DVP20ES200RE	
	100~240 V _{AC}	Transistor	12	8	DVP20ES200TE	
	100~240 V _{AC}	Relay	16	16	DVP32ES200RE	
	100~240 V _{AC}	Transistor	16	16	DVP32ES200TE	
	100~240 V _{AC}	Relay	24	16	DVP40ES200RE	
	100~240 V _{AC}	Transistor	24	16	DVP40ES200TE	
	100~240 V _{AC}	Relay	36	24	DVP60ES200RE	
100~240 V _{AC}	Transistor	36	24	DVP60ES200TE		
DVP-EX2 Series Analog PLC	100~240 V _{AC}	Relay	8	6	DVP20EX200R	
		Analog	4	2		
	100~240 V _{AC}	Transistor	8	6	DVP20EX200T	
		Analog	4	2		
DVP-EX2 Series Temperature/ Analog PLC	100~240 V _{AC}	Relay	16	10	DVP30EX200R	
		Analog	3	1		
	100~240 V _{AC}	Transistor	16	10	DVP30EX200T	
		Analog	3	1		
Fastest execution time of basic instructions		0.35 μs	Execution time of MOV instruction		3.4 μs	





*1: Built-in SD card slot

DVP-ES2/EX2 Series Digital I/O Module (AC power supply)

Product Name	Power Supply	Output Method	Inputs	Outputs	Model Name	Certificates
Digital Module	100~240 V _{AC}	Relay	-	24	DVP24XN200R	
	100~240 V _{AC}	Transistor	-	24	DVP24XN200T	
	100~240 V _{AC}	Relay	16	8	DVP24XP200R	
	100~240 V _{AC}	Transistor	16	8	DVP24XP200T	
	100~240 V _{AC}	Relay	16	16	DVP32XP200R	
	100~240 V _{AC}	Transistor	16	16	DVP32XP200T	

Ordering Information

DVP-ES2/EX2 Series Digital/Analog/Special Module (24V_{DC})



Product Name	Output Method	Inputs	Outputs	Model Name	Certificates
Digital Module	-	8	-	DVP08XM211N	
	Relay	-	8	DVP08XN211R	
	Transistor	-	8	DVP08XN211T	
	Relay	4	4	DVP08XP211R	
	Transistor	4	4	DVP08XP211T	
	-	16	-	DVP16XM211N	
	Relay	-	16	DVP16XN211R	
	Transistor	-	16	DVP16XN211T	
	Relay	8	8	DVP16XP211R	
Transistor	8	8	DVP16XP211T		
Analog I/O Module	<ul style="list-style-type: none"> 4 points of analog voltage (10V, 5V)/current (20 mA, 0~20 mA, 4~20 mA) input ^{**1} Resolution: 14-bit (-32,000~+32,000) 			DVP04AD-E2	
	<ul style="list-style-type: none"> 4 points of analog voltage (-10V~+10V)/current (0~20 mA, 4~20 mA) output ^{**1} Resolution: 14-bit (-32,000~+32,000)/(0~+32,000) 			DVP04DA-E2	
	<ul style="list-style-type: none"> 2 points of analog voltage (-10V~+10V)/current (0~20 mA, 4~20 mA) output ^{**1} Resolution: 14-bit (-32,000~+32,000)/(0~+32,000) 			DVP02DA-E2	
	<ul style="list-style-type: none"> 4 points of analog voltage (10V, 5V)/current (20 mA, 0~20 mA, 4~20 mA) input ^{**1} Input resolution: 14-bit (-32,000~+32,000) 2 points of analog voltage (-10V~+10V)/current (0~20 mA, 4~20 mA) output Output resolution: 14-bit (-32,000~+32,000)/(0~+32,000) 			DVP06XA-E2	
Temperature Measurement Module	<ul style="list-style-type: none"> 4 points of platinum RTD (Pt100, Pt1000, Ni100, Ni1000) sensor input/0~300Ω resistance input ^{**1} Resolution: 16-bit With PID temperature control 			DVP04PT-E2	
	<ul style="list-style-type: none"> 4 points of thermocouple (J, K, R, S, T, E, N Type) sensor input/-80mV~+80mV voltage input ^{**1} Resolution: 20-bit With PID temperature control 			DVP04TC-E2	
Absolute Resolver Module	<ul style="list-style-type: none"> Converts 1 set of resolver input signal (angle/speed) into digital signals Resolution: 12-bit Supports disconnection detection for distance up to 50m 			DVP10RC-E2	
Extension module	<ul style="list-style-type: none"> Extends distance between the I/O modules of the DVP-ES2 Series within a given distance 			DVPAEXT01-E2	

*1. Digital/analog photocoupler isolation. No isolation among channels.

DVP-EH3 Series PLC

Product name	Power Supply	Output Method	Inputs	Outputs	Model Name	Certificates
DVP-EH3 Series High Performance PLC	100~240V _{AC}	Relay	8	8	DVP16EH00R3	
	100~240V _{AC}	Transistor	8	8	DVP16EH00T3	
	100~240V _{AC}	Relay	12	8	DVP20EH00R3	
	100~240V _{AC}	Transistor	12	8	DVP20EH00T3	
	100~240V _{AC}	Transistor	16	16	DVP32EH00T3	
	100~240V _{AC}	Relay	16	16	DVP32EH00R3	
	100~240V _{AC}	Differential + Relay	16	16	DVP32EH00M3	
	100~240V _{AC}	Differential + Transistor	16	16	DVP32EH00MT	
	100~240V _{AC}	Relay	16	16	DVP32EH00R3-L	
	100~240V _{AC}	Transistor	16	16	DVP32EH00T3-L	
	100~240V _{AC}	Transistor	24	16	DVP40EH00T3	
	100~240V _{AC}	Relay	24	16	DVP40EH00R3	
	100~240V _{AC}	Relay	24	24	DVP48EH00R3	
	100~240V _{AC}	Transistor	24	24	DVP48EH00T3	
	100~240V _{AC}	Relay	32	32	DVP64EH00R3	
	100~240V _{AC}	Transistor	32	32	DVP64EH00T3	
	100~240V _{AC}	Relay	40	40	DVP80EH00R3	
100~240V _{AC}	Transistor	40	40	DVP80EH00T3		
Execution time of basic instructions			0.24 μs			

DVP-EH3 Series Digital/Analog Module

Product Name	Output Method	Inputs	Outputs	Model Name	Certificates
Digital Module	Relay	4	4	DVP08HP11R	
	Transistor	4	4	DVP08HP11T	
	Relay	-	8	DVP08HN11R	
	Transistor	-	8	DVP08HN11T	
	-	8	-	DVP08HM11N	
	Relay	8	8	DVP16HP11R	
	Transistor	8	8	DVP16HP11T	
	-	16	-	DVP16HM11N	
	-	32	-	DVP32HM11N	
	Relay	-	32	DVP32HN00R	
	Transistor	-	32	DVP32HN00T	
	Relay	16	16	DVP32HP00R	
	Transistor	16	16	DVP32HP00T	
	Relay	24	24	DVP48HP00R	
Transistor	24	24	DVP48HP00T		
Analog Module	<ul style="list-style-type: none"> 4 points of analog voltage (-10V~+10V)/current (-20mA~+20mA) ^{*1} Input resolution: 14-bit Built-in RS-485 interface 			DVP04AD-H2	
	<ul style="list-style-type: none"> 4 points of analog voltage (0V~+10V)/current (0mA~+20mA) output ^{*1} Resolution: 12-bit Built-in RS-485 interface 			DVP04DA-H2	
	<ul style="list-style-type: none"> 4 points of analog voltage (-10V~+10V)/current (-20mA~+20mA) input 2 points of analog voltage (0V~+10V)/current (0mA~+20mA) output Resolution: 12-bit Built-in RS-485 interface 			DVP06XA-H2	
	<ul style="list-style-type: none"> 4 points of platinum RTD (Pt100, Pt1000, Ni100, Ni1000) sensor input ^{*1} / 0~300Ω or 0~3000Ω resistance input Resolution: 0.1°C Built-in RS-485 interface 			DVP04PT-H2	
	<ul style="list-style-type: none"> 4 points of thermocouple (J, K, R, S, T, E, N Type) sensor input ^{*1} / 0~150mV voltage input Resolution: 0.1°C Built-in RS-485 interface 			DVP04TC-H2	
	<ul style="list-style-type: none"> 8 points of thermocouple (J, K, R, S, T, E, N Type) sensor input ^{*1} / 0~150mV or ±150mV voltage input Resolution: 0.1°C Built-in RS-485 interface 			DVP08TC-H2	
	<ul style="list-style-type: none"> 4 channels of differential voltage (-10V~+10V)/current (-20mA~+20mA) input Resolution: 16-bit Built-in RS-485 interface 			DVP04AD-H3	
	<ul style="list-style-type: none"> 4 channels of voltage (-10V~+10V)/current (0~+20mA) output Resolution: 16-bit Built-in RS-485 interface 			DVP04DA-H3	
<ul style="list-style-type: none"> 4 channels of differential voltage (-10V~+10V)/ current (-20mA~+20mA) input 2 channels of voltage (-10V~+10V)/current (0~+20mA) output Resolution: 16-bit Built-in RS-485 interface 			DVP06XA-H3		





*1. Digital/analog photocoupler isolation. No isolation among channels.

DVP-EH3 Series Extension Module/Function Card

Product Name	Description	Model Name	Certificates
Positioning Module	Servo position control module (single axis, 200 kHz)	DVP01PU-H2	
High-Speed Counter	High-speed counter module (1CH)	DVP01HC-H2	
Communication Module	PROFIBUS DP slave communication module	DVPPF02-H2	
	CANopen slave communication module	DVPCP02-H2	
	DeviceNet slave communication module	DVPDT02-H2	
Function Card	RS-232 port conversion (DVP-EH2: COM2; DVP-EH3: COM3)	DVP-F232	
	RS-422 port conversion (DVP-EH2: COM2; DVP-EH3: COM3)	DVP-F422	
	RS-485 port extension (COM3) (DVP-EH3 only)	DVP-F485	
	<ul style="list-style-type: none"> 2 points of analog voltage (0~10V)/current (0~20mA) input Resolution: 12-bit 	DVP-F2AD	
	<ul style="list-style-type: none"> 2 points of analog voltage (0~10V)/current (0~20mA) output Resolution: 12-bit 	DVP-F2DA	
	Ethernet communication card (compatible with controllers built-in with 32 I/O and above)	DVP-FEN01	



Ordering Information

DVP-S Series PLC

Product Name	Power Supply	Output Method	Inputs	Outputs	Model Name	Certificates
DVP-SV2 Series Functional Slim PLC	24V _{DC}	Relay	16	12	DVP28SV11R2	
	24V _{DC}	Transistor	16	12	DVP28SV11T2	
	24V _{DC}	Transistor (PNP)	16	12	DVP28SV11S2	
	24V _{DC}	Transistor	10 (2AI)	12	DVP24SV11T2	
Execution time of basic instructions			0.24 μs			
DVP-SS2 Series Standard Slim PLC	24V _{DC}	Relay	16	12	DVP28SS211R New	
	24V _{DC}	Transistor	16	12	DVP28SS211T New	
	24V _{DC}	Relay	8	6	DVP14SS211R	
	24V _{DC}	Transistor	8	6	DVP14SS211T	
	24V _{DC}	Transistor(PNP)	8	4	DVP12SS211S	
DVP-SA2 Series Advanced Slim PLC	24V _{DC}	Relay	16	12	DVP28SA211R New	
	24V _{DC}	Transistor	16	12	DVP28SA211T New	
	24V _{DC}	Relay	8	4	DVP12SA211R	
	24V _{DC}	Transistor	8	4	DVP12SA211T	
DVP-SX2 Series Analog Slim PLC	24V _{DC}	Relay	8 (4AI)	6 (2AO)	DVP20SX211R	
	24V _{DC}	Transistor	8 (4AI)	6 (2AO)	DVP20SX211T	
	24V _{DC}	Transistor (PNP)	8 (4AI)	6 (2AO)	DVP20SX211S	
Fastest execution time of basic instructions		0.35 μs	Execution time of MOV instruction		3.4 μs	
DVP-SE Series Network Type Slim PLC	24V _{DC}	Relay	14	12	DVP26SE11R ^(*) New	
	24V _{DC}	Transistor	14	12	DVP26SE11T ^(*) New	
	24V _{DC}	Relay	8	4	DVP12SE11R	
	24V _{DC}	Transistor	8	4	DVP12SE11T	
Fastest execution time of basic instructions		0.64 μs	Execution time of MOV instruction		2 μs	
DVP-SX Series Analog Slim PLC	24V _{DC}	Relay	4 (2AI)	2 (2AO)	DVP10SX11R	
	24V _{DC}	Transistor	4 (2AI)	2 (2AO)	DVP10SX11T	
Fastest execution time of basic instructions		3.8 μs	Execution time of MOV instruction		5.04 μs	

Note 1: Please contact our distributors for release date

DVP-S Series Digital/Analog Module

Product name	Output Method	Inputs	Outputs	Model Name	Certificates
Digital Module	Relay	-	6	DVP06SN11R	
	Relay	-	8	DVP08SN11R	
	Transistor	-	8	DVP08SN11T	
	Transistor	-	16	DVP16SN11T	
	Relay	4	4	DVP08SP11R	
	Transistor	4	4	DVP08SP11T	
	-	8	-	DVP08SM11N	
	-	8	-	DVP08SM10N	
	Transistor (PNP)	-	8	DVP08SN11TS	
	Digital switch	8	-	DVP08ST11N	
	Relay	8	8	DVP16SP11R	
	Transistor (PNP)	4	4	DVP08SP11TS	
	Transistor (NPN)	8	8	DVP16SP11T	
	Transistor (PNP)	8	8	DVP16SP11TS	
	Transistor (PNP)	-	16	DVP16SN11TS	
	-	16	-	DVP16SM11N	
	Transistor, MIL	-	32	DVP32SN11TN	
MIL	32	-	DVP32SM11N		
Product Name	Description			Model Name	Certificates
Analog I/O Module	<ul style="list-style-type: none"> 4 points of analog input voltage (-10V~+10V)/ current (-20mA~+20mA) Input resolution: 14-bit 		<ul style="list-style-type: none"> Built-in RS-485 interface Differential input 	DVP04AD-S2	
	<ul style="list-style-type: none"> 4 points of analog output voltage (0V~+10V)/ current (0mA~+20mA) 		<ul style="list-style-type: none"> Output resolution: 12-bit Built-in RS-485 interface 	DVP04DA-S2	
	<ul style="list-style-type: none"> Analog input+output module (6 points) 4 points of analog input voltage (-10V~+10V)/ current (-20mA~+20mA) 2 points of analog output voltage (0V~+10V)/ current (0mA~+20mA) 		<ul style="list-style-type: none"> Input/output resolution: 12-bit Built-in RS-485 interface Differential input 	DVP06XA-S2	

DVP-S Series Analog Module

Product Name	Description	Model Name	Certificates
Analog I/O Module	<ul style="list-style-type: none"> 4 points of analog input voltage (-10V~+10V)/current (-20mA~+20mA) Input resolution: 14-bit 	<ul style="list-style-type: none"> Built-in RS-485 interface Single-ended input 	DVP04AD-S
	<ul style="list-style-type: none"> 4 points of analog output voltage (0V~+10V)/current (0mA~+20mA) Output resolution: 12-bit 	<ul style="list-style-type: none"> Built-in RS-485 interface 	DVP04DA-S
	<ul style="list-style-type: none"> 2 points of analog output voltage (0V~+10V)/current (0mA~+20mA) Output resolution: 12-bit 	<ul style="list-style-type: none"> Built-in RS-485 interface 	DVP02DA-S
	<ul style="list-style-type: none"> 6 points of analog input voltage (-10V~+10V)/current (-20mA~+20mA) Input resolution: 14-bit 	<ul style="list-style-type: none"> Built-in RS-485 interface 	DVP06AD-S
	<ul style="list-style-type: none"> Analog input+output modules (6 points) 4 points of analog input voltage (-10V~+10V)/current (-20mA~+20mA) 2 points of analog output voltage (0V~+10V)/current (0mA~+20mA) 	<ul style="list-style-type: none"> Input/output resolution: 12-bit Built-in RS-485 interface Single-ended input 	DVP06XA-S



DVP-S Series Extension Module/High-Speed Module (Left-side)

Product Name	Description	Model Name	Certificates	
High-Speed Analog I/O Module (Left-side)	<ul style="list-style-type: none"> 4 groups of analog input^{*1} Signal range: 1~5V, 0~5V, -5~5V, 0~10V, -10~10V, 4~20mA, 0~20mA, -20~20mA Resolution: 16-bit Single channel On/Off setup enhances entire conversion efficiency Conversion time: 250µs/point Off-line alarm (1~5V, 4~20mA) 	DVP04AD-SL		
	<ul style="list-style-type: none"> 4 groups of analog output^{*1} Signal range: 0~10V, -10~10V, 4~20mA, 0~20mA Resolution: 16-bit Offers single channel On/Off setup Conversion time: 250µs/point 	DVP04DA-SL		
High-Speed Load Cell Module (Left-side)	<ul style="list-style-type: none"> 1 set of load cell module^{*1} Resolution: 24-bit for hardware(ADC), 32-bit for data output 	<ul style="list-style-type: none"> Connectable to 4-wire/6-wire load cell sensor Measurable range: 0~80mV/V 		DVP201LC-SL
	<ul style="list-style-type: none"> 1 set of load cell module^{*1} Resolution: 24-bit for hardware(ADC), 32-bit for data output Connectable to 4-wire/6-wire load cell sensor 	<ul style="list-style-type: none"> Measurable range: 0~80mV/V Built-in I/O control: 2DI/4DO/1AO 		DVP211LC-SL
	<ul style="list-style-type: none"> 2 sets of load cell module^{*1} Resolution: 24-bit for hardware(ADC), 32-bit for data output 	<ul style="list-style-type: none"> Connectable to 4-wire/6-wire load cell sensor Measurable range: 0~80mV/V 		DVP202LC-SL
	<ul style="list-style-type: none"> Supports 2 channels of load cell signal input^{*1} Resolution: 20-bit for hardware(ADC), 16-bit for data output Connectable to 4-wire/6-wire load cell sensor Measurable range: 0~6mV/V 	DVP02LC-SL		
	<ul style="list-style-type: none"> Supports 1 channel of load cell signal input^{*1} Resolution: 20-bit for hardware(ADC), 32-bit for data output Connectable to 4-wire/6-wire load cell sensor Measurable range: 0~6mV/V 	DVP01LC-SL		
Temperature Measurement Module	<ul style="list-style-type: none"> 6 points of platinum RTD (Pt100, Pt1000, Ni100, Ni1000) sensor input Resolution: 0.1°C 	DVP06PT-S		
	<ul style="list-style-type: none"> 4 points of platinum RTD (Pt100, Pt1000, Ni100, Ni1000) sensor input^{*1} (Version 4.06 and above supports Pt1000, Ni100, Ni1000) Resolution: 0.1°C Built-in RS-485 interface 	DVP04PT-S		
	<ul style="list-style-type: none"> 4 points of thermocouple (J, K, R, S, T type) sensor input^{*1} Resolution: 0.1°C Built-in RS-485 interface 	DVP04TC-S		
	<ul style="list-style-type: none"> 2 points of universal analog input: 0~10V, 0~20mA, 4~20mA; Thermocouple: J, K, R, S, T, E, N, B, C, L, U, TXK, PLII; RTD: Pt100, JPt100, Pt1000, Cu50, Cu100, Ni100, Ni1000, LG-Ni1000 Resolution: analog 16-bit; Sensor: 0.1°C 4 points of NPN transistor output: 24V_{DC}/300mA Output point: built-in PID program control/manual control 	DVP02TUN-S New		
	<ul style="list-style-type: none"> 2 points of universal analog input: 0~10V, 0~20mA, 4~20mA; Thermocouple: J, K, R, S, T, E, N, B, C, L, U, TXK, PLII; RTD: Pt100, JPt100, Pt1000, Cu50, Cu100, Ni100, Ni1000, LG-Ni1000 Resolution: analog 16-bit; Sensor: 0.1°C 4 points of relay output: 24V_{DC}/3A Output point: built-in PID program control/manual control 	DVP02TUR-S New		
	<ul style="list-style-type: none"> 2 points of universal analog input: 0~10V, 0~20mA, 4~20mA; Thermocouple: J, K, R, S, T, E, N, B, C, L, U, TXK, PLII; RTD: Pt100, JPt100, Pt1000, Cu50, Cu100, Ni100, Ni1000, LG-Ni1000 Resolution: analog 16-bit; Sensor: 0.1°C 2 points of analog output: 0~10V, 0~20mA, 4~20mA Output point: built-in PID program control/manual control 	DVP02TUL-S New		

*1. Digital/analog photocoupler isolation. No isolation among channels.

Ordering Information

DVP-S Series Extension Module/High-Speed Module (Left-side)

Product Name	Description	Model Name	Certificates
Positioning Module	Servo position control module (single axis, 200 kHz)	DVP01PU-S	
Communication Module	DeviceNet slave communication module	DVPDT01-S	
	PROFIBUS DP slave communication module	DVPPF01-S	
Left-Side High-Speed Communication Module	Ethernet communication module, 10/100 Mbps	DVPEN01-SL	
	DeviceNet master communication module, 500 Kbps	DVPDNET-SL	
	CANopen master communication module, 1 Mbps	DVPCOPM-SL	
	PROFIBUS DP slave communication module, 12 Mbps	DVPPF02-SL	
	RS-485/RS-422, serial communication module, 460 Kbps	DVPSCM12-SL	
	BACnet MS/TP Slave communication module, 460 Kbps	DVPSCM52-SL	
Remote I/O Module	RS-485 remote I/O module, connectable to DVP-S series I/O modules	RTU-485	
	Ethernet remote I/O module, connectable to DVP-S series I/O modules	RTU-EN01	
	DeviceNet remote I/O module, connectable to DVP-S series I/O modules	RTU-DNET	
	PROFIBUS remote I/O module, connectable to DVP-S series I/O modules	RTU-PD01	
Remote Temperature Control Module	<ul style="list-style-type: none"> 2 points of universal analog input: 0~10V, 0~20mA, 4~20mA; Thermocouple: J, K, R, S, T, E, N, B, C, L, U, TXK, PLII; RTD: Pt100, JPt100, Pt1000, Cu50, Cu100, Ni100, Ni1000, LG-Ni1000 Resolution: analog 16-bit; Sensor: 0.1 °C 4 points of NPN transistor output: 24V_{DC}/300mA Output point: built-in PID program control/manual control 	DVP02TKN-S New	
	<ul style="list-style-type: none"> 2 points of universal analog input: 0~10V, 0~20mA, 4~20mA; Thermocouple: J, K, R, S, T, E, N, B, C, L, U, TXK, PLII; RTD: Pt100, JPt100, Pt1000, Cu50, Cu100, Ni100, Ni1000, LG-Ni1000 Resolution: analog 16-bit; Sensor: 0.1 °C 4 points of relay output: 24V_{AC}/3A Output point: built-in PID program control/manual control 	DVP02TKR-S New	
	<ul style="list-style-type: none"> 2 points of universal analog input: 0~10V, 0~20mA, 4~20mA; Thermocouple: J, K, R, S, T, E, N, B, C, L, U, TXK, PLII; RTD: Pt100, JPt100, Pt1000, Cu50, Cu100, Ni100, Ni1000, LG-Ni1000 Resolution: analog 16-bit; Sensor: 0.1 °C 2 points of analog output: 0~10V, 0~20mA, 4~20mA Output point: built-in PID program control/manual control 	DVP02TKL-S New	

Communication Converter

Product Name	Description	Model Name	Certificates
Converter	USB to RS-485 converter	IFD6500	
	USB to CAN converter	IFD6503	
	USB to RS-485 converter	IFD6530	
	MODBUS TCP to RS-232/485 converter	IFD9506	
	EtherNet/IP to RS-232/485 converter	IFD9507	
	DeviceNet to RS-232/485 converter	IFD9502	
	CANopen to RS-232/485 converter	IFD9503	
	RS-232 to RS-422/485 isolated converter	IFD8500-A	
	RS-485 to RS-422 isolated repeater	IFD8510-A	
	RS-422/485 to RS-232 addressable isolated converter	IFD8520	



DVP-PM Series

Product Name	Power Supply	Output Method	Inputs	Outputs	Model Name	Certificates
Standard Motion Controller	100~240V _{AC}	Differential	16	16	DVP10PM00M	
		(Built-in 4-axis of independent 1MHz pulse output)				
Advanced Motion Controller	100~240V _{AC}	Differential	8	8	DVP20PM00DT	
		(Built-in 2-axis of independent 500 kHz pulse output)				
		(Built-in 3-axis of independent 500 kHz pulse output)				
Extension Module		Description			Model Name	
DVP-PM communication card		Ethernet/CANopen communication card			DVP-FPMC	
Execution time of basic instructions		0.13 μs		Execution time of MOV instruction		3.74 μs

DVP-MC Series

Product Name	Power Supply	Communication Protocol	Axes Controlled	Inputs	Outputs	Model Name	Certificates
Multi-axis Motion Controller	24V _{DC}	CANopen DS402	16	8	4	DVP10MC11T	
			24	16	8	DVP15MC11T New	
			6	16	8	DVP15MC11T-06 New	
		EtherCAT	24	16	8	DVP50MC11T New	
			6	16	8	DVP50MC11T-06 New	

TP Series

Product Name	Description										Model	Certificates
TP02	Resolution: 160 x 32, Serial COM ports: RS-232 & RS-485										TP02G-AS1	
TP04	Resolution: 128 x 64, Serial COM ports: RS-232 & RS-422 / RS-485										TP04G-AS2	
	Resolution: 192 x 64, Serial COM ports: RS-232 & RS-422 / RS-485										TP04G-AL2	
	Resolution: 192 x 64, Serial COM ports: RS-232										TP04G-AL-C	
	Resolution: 192 x 64, Serial COM ports: RS-232 & RS-422 / RS-485, 0 ~ 9 numeric keys available										TP04G-BL-C	
TP04	Resolution: 192 x 64, Serial COM ports: RS-232										TP04G-AL-C	
Product Name	Description	DI	DO	AI ^{*2}	AO ^{*2}	PT	AX ^{*1}	LC	Output Type	Model	Certificates	
TP04P	Resolution: 192 x 64 Serial COM ports: USB & RS-485*2	4 (60Hz)	4						Relay	TP04P-08TP1R		
		8	8						Relay	TP04P-16TP1R		
		16	16						Relay	TP04P-32TP1R		
		8	8	4 (V/I)	2 (V/I)				Relay	TP04P-22XA1R		
		8	8	2 (I)	1 (I)	2			Relay	TP04P-21EX1R		
		8	8						Transistor	TP04P-16TP1T		
		16	16						Transistor	TP04P-32TP1T		
		8	8	4 (V/I)	2 (V/I)				Transistor	TP04P-22XA1T		
		8	8	2 (I)	1 (I)	2			Transistor	TP04P-21EX1T		
TP70P	Resolution: 800 x 400 Serial COM ports: USB & RS-485*2	9	16	4 (V/I)	2 (V/I) 4 (I)		2	1	Transistor	TP04P-20EXL1T ^{*3}		
		8	8						Relay	TP70P-16TP1R		
		16	16						Relay	TP70P-32TP1R		
		8	8	4 (V/I)	2 (V/I)				Relay	TP70P-22XA1R		
		8	8	2 (I)	1 (I)	2			Relay	TP70P-21EX1R		
		8	8						Transistor	TP70P-16TP1T		
		16	16						Transistor	TP70P-32TP1T		
		8	8	4 (V/I)	2 (V/I)				Transistor	TP70P-22XA1T		
		8	8	2 (I)	1 (I)	2			Transistor	TP70P-21EX1T		
TP08	Resolution: 240 x 128 / Serial COM ports: RS-232, RS-422 & RS-485 / 0~9 numeric keypad								2	1	Transistor	TP70P-211LC1T ^{*3}
TP08	Resolution: 240 x 128 / Serial COM ports: RS-232, RS-422 & RS-485 / 0~9 numeric keypad										Transistor	TP08G-BT2

*1: Universal analog input (mA, V, RTD)

*2: V (Voltage), I (Current)

*3: USB & RS-485 are design with isolation

Software

Product Name	Description	OS (Windows-based software)
ISPSOFT	PLC editing software for AH, AS and DVP Series (supports 5 programming languages: LD, FBD, SFC, ST, IL)	Windows 2000, XP, Vista, Windows 7 (32-bit/64-bit)
WPLSOFT	Programming software for DVP Series	Windows 98, Me, NT4.0, 2000, XP, Vista, Windows 7 (32-bit/64-bit)
TPEditor	Editing software for TP Series	Windows 98, Me, NT4.0, 2000, XP, Vista, Windows 7 (32-bit/64-bit)
PMSOFT	Programming software for DVP-PM series	Windows 2000, XP, Vista, Windows 7 (32-bit/64-bit)
DCISOFT	Delta communication integration software	Windows 2000, XP, Vista, Windows 7 (32-bit/64-bit)
DeviceNet Builder	DeviceNet configuration software	Windows 2000, XP, Vista, Windows 7 (32-bit/64-bit)
CANopen Builder	CANopen configuration software	Windows 2000, XP, Vista, Windows 7 (32-bit/64-bit)
NetView Builder	CAN bus message analysis software	Windows 2000, XP, Vista, Windows 7 (32-bit)

Ordering Information

Starter Kit

Product Name	Model Name	Contents
New Delta PLC Starter Kit	UT-14SS2-A	DVP14SS211R (PLC), DOP-B07S410 (HMI) and accessory
	UT-12SE-A1	DVP12SE11R (PLC), DOP-B07E411 (HMI) and accessory

Industrial Power Supply

Series	Power Supply	Inputs	Outputs	Power	Output Current	Model Name	Certificates
DVP	1-phase	85~264V _{AC}	24V _{DC}	24W	1A	DVPPS01	
				48W	2A	DVPPS02	
				120W	5A	DVPPS05	

*Note: For more ordering information, please refer to the catalogue for Delta Industrial Power Supply.

Accessories

Type	Model Name	Description	Specification		Applicable Modules
			Length	Connector / Terminal block	
PLC Programming and Serial Communication Cable	UC-PRG015-01A	Communication cable for PLC (mini USB) to PC	1.5 m	PC (USB↔mini USB) PLC	DVP-SE / DVP-SX2 / AH500
	UC-PRG015-02A	Communication cable for TP (USB B type) to PC	1.5 m	PC (USB↔USB B type) TP	TP70P / TP04P / DOP
	UC-PRG020-12A	Communication cable for PLC (DB9 female / 8-pin mini-DIN male) to PC	2 m	PC (DB9 female↔8-pin mini-DIN male) PLC	DVP / TP RS-232
	UC-PRG030-01A	Communication cable for PLC (mini USB) to PC	3 m	PC (USB↔mini USB) PLC	DVP-SE / SX2 AH500
	UC-PRG030-02A	Communication cable for TP (USB B type) to PC	3 m	PC (USB↔USB B type) TP	TP70P / TP04P / DOP
	UC-PRG030-10A	Communication cable for PLC / HMI / TP (DB9 female) to PC	3 m	PC (DB9 female↔DB9 female) PLC / HMI / TP	PLC / HMI / TP (DB9 female)
	UC-PRG030-20A	Communication cable for PLC / HMI (RJ45) to PC	3 m	PC (RJ45↔RJ45) PLC / HMI	DVP-SE DVPEN02-L AHCPU5□□-EN AH10EN-5A
	UC-MS010-02A	Communication cable for PLC (8-pin mini-DIN male) to PC	1 m	PC (DB9 female↔8-pin mini-DIN male) PLC	DVP PLC RS-232
	UC-MS020-01A	Communication cable for PLC (8-pin mini-DIN male) to PC	2 m	PC (DB9 female↔8-pin mini-DIN male) PLC	
	UC-MS020-06A	Communication cable for PLC (8-pin mini-DIN male) to HMI	2 m	HMI (DB9male↔8-pin mini-DIN male) PLC	
	UC-MS030-01A	Communication cable for PLC (8-pin mini-DIN male) to PC	3 m	PC (DB9 female↔8-pin mini-DIN male) PLC	
	UC-MS030-06A	Communication cable for PLC (8-pin mini-DIN male) to HMI	3 m	HMI (DB9male↔8-pin mini-DIN male) PLC	
I/O External Terminal Module	UC-ET010-24A	I/O extension cable for connecting external terminal modules	1 m	PLC (MIL IDC40↔IDC40) external terminal modules	
	UC-ET010-24B	I/O extension cable for connecting external terminal modules	1 m	PLC (MIL IDC40↔IDC40) external terminal modules (shielded wire)	DVP32SM11N↔UB-10-ID32A DVP32SN11TN↔UB-10-OT32A
	UC-ET010-24C	I/O extension cable for connecting external terminal modules	1 m	PLC (MIL IDC40↔IDC20x2) external terminal modules	DVP32SN11TN↔UB-10-OR16A
	UC-ET010-24D	I/O extension cable for connecting external terminal modules	1 m	PLC (MIL IDC40↔IDC20x2) external terminal modules (shielded wire)	DVP32SN11TN↔UB-10-OR16A
	UC-ET020-24B	I/O extension cable for connecting external terminal modules	2 m	PLC (MIL IDC40↔IDC40) external terminal modules (shielded wire)	DVP32SM11N↔UB-10-ID32A DVP32SN11TN↔UB-10-OT32A
	UC-ET020-24D	I/O extension cable for connecting external terminal modules	2 m	PLC (MIL IDC40↔IDC20x2) external terminal modules (shielded wire)	DVP32SN11TN↔UB-10-OR16A
	UC-ET030-24B	I/O extension cable for connecting external terminal modules	3 m	PLC (MIL IDC40↔IDC40) external terminal modules (shielded wire)	DVP32SM11N↔UB-10-ID32A DVP32SN11TN↔UB-10-OT32A
	UC-ET030-24D	I/O extension cable for connecting external terminal modules	3 m	PLC (MIL IDC40 to IDC20x2) external terminal modules (shielded wire)	DVP32SN11TN↔UB-10-OR16A

Accessories

Type	Model Name	Description	Specification		Applicable Modules
			Length	Connector / Terminal block	
Motion Control Cable / Industrial Communication Cable	UC-CMC003-01A	CANopen communication cable	0.3 m	RJ45	DVP-COPM-SL DVP10MC11T DVP15MC11T New DVP15MC11T-06 New DVPCP02-H2 TAP-CN03
	UC-CMC005-01A	CANopen communication cable	0.5 m	RJ45	
	UC-CMC010-01A	CANopen communication cable	1 m	RJ45	
	UC-CMC015-01A	CANopen communication cable	1.5 m	RJ45	
	UC-CMC020-01A	CANopen communication cable	2 m	RJ45	
	UC-CMC030-01A	CANopen communication cable	3 m	RJ45	
	UC-CMC050-01A	CANopen communication cable	5 m	RJ45	
	UC-CMC100-01A	CANopen communication cable	10 m	RJ45	
	UC-CMC200-01A	CANopen communication cable	20 m	RJ45	
	UC-EMC003-02A	EtherCAT communication cable	0.3m	RJ45	DVP50MC11T New DVP50MC11T-06 New
	UC-EMC005-02A	EtherCAT communication cable	0.5m	RJ45	
	UC-EMC010-02A	EtherCAT communication cable	1m	RJ45	
	UC-EMC020-02A	EtherCAT communication cable	2m	RJ45	
	UC-EMC050-02A	EtherCAT communication cable	5m	RJ45	
	UC-EMC100-02A	EtherCAT communication cable	10m	RJ45	
	UC-EMC200-02A	EtherCAT communication cable	20m	RJ45	
Industrial Communication Cable	UC-DN01Z-01A	DeviceNet/CANopen communication cable (Trunk cable - thick)	On customer's demand (up to 305 m)	--	DeviceNet/CANopen related models
	UC-DN01Z-02A	DeviceNet/CANopen communication cable (Drop cable - thin)		--	
	UC-PF01Z-01A	PROFIBUS communication cable		--	
External Terminal Module	UB-10-OR16A	external terminal module for DVP32SN output module	--	16-point relay output, 20-pin MIL	DVP32SN11TN
	UB-10-OT32A	external terminal module for DVP32SN output module	--	32-point transistor output, 40-pin MIL	DVP32SN11TN
	UB-10-ID32A	external terminal module for DVP32SM digital input module	--	32-point input, MIL	DVP32SM11TN
Connector	UN-03EN-04A	RJ45 connector	--	--	--
	UN-03PF-01A	PROFIBUS connector	--	--	PROFIBUS related models
	UN-03PF-02A	PROFIBUS connector	--	--	
	UN-03PF-03A	PROFIBUS connector	--	--	
Peripheral Accessory	Data backup memory card (DVP-EH3 only)				DVP-512FM
	Data backup memory card (DVP-ES2 only)				DVP-E64FM
	Data backup memory card (64k words)				DVPPCC01
	Data backup memory card (TP only)				TP-PCC01
	Communication cable for PC (9-pin & 25-pin D-Sub) and PLC, 1.5 m				DVPACAB215
	Communication cable for PC (9-pin & 25-pin D-Sub) and PLC, 3 m				DVPACAB230
	4 types of RS-485 connectors				ADP485-01
	Connection cable for ADP485-01 and ASDA-A series servo				ADPCAB03A
	Connection cable for ADP485-01 and ASDA-B series servo				ADPCAB03B
	I/O extension cable for DVP-ES/EX Series, 0.3 m				DVPACAB403
	Extension cable for DVP-EH series PLC and extension module, 0.7 m				DVPACAB4A07
	DeviceNet/CANopen power distribution box				TAP-CP01
	DeviceNet/CANopen distribution box, 1 for 2				TAP-CN01
	DeviceNet/CANopen distribution box, 2 for 3				TAP-CN02
	DeviceNet/CANopen distribution box, 2 for 3 RJ45				TAP-CN03
	3.6V lithium battery (unchargeable) for DVP-EH/SX Series PLC				DVPABT01
	Terminal resistance for CANopen communication (RJ45)				TAP-TR01
	Programming cable for TP Series				UCPRG030-10A